



DEEP SEA ELECTRONICS PLC

DSE6110 MKII & DSE6120 MKII

Operator Manual

Document Number: 057-236

Author: Ashley Senior





Deep Sea Electronics Plc
Highfield House
Hunmanby
North Yorkshire
YO14 0PH
ENGLAND

Sales Tel: +44 (0) 1723 890099
Sales Fax: +44 (0) 1723 893303

E-mail: sales@deepseapl.com
Website: www.deepseapl.com

DSE6110 MKII & DSE6120 MKII Operator Manual

© Deep Sea Electronics Plc

All rights reserved. No part of this publication may be reproduced in any material form (including photocopying or storing in any medium by electronic means or other) without the written permission of the copyright holder except in accordance with the provisions of the Copyright, Designs and Patents Act 1988.

Applications for the copyright holder's written permission to reproduce any part of this publication must be addressed to Deep Sea Electronics Plc at the address above.

The DSE logo and the names DSEgenset®, DSEats® and DSEpower® are UK registered trademarks of Deep Sea Electronics PLC.

Any reference to trademarked product names used within this publication is owned by their respective companies.

Deep Sea Electronics Plc reserves the right to change the contents of this document without prior notice.

Amendments Since Last Publication

Amd. No.	Comments
1	Initial Release
2	Added cooldown in stop mode, reset maintenance alarm from front panel, audible alarm output with configurable duration, cooldown at idle speed, EPA tier 4 screen, user configurable CAN, start and stop in event log, additional alarms

Typeface: The typeface used in this document is *Arial*. Care should be taken not to mistake the upper case letter I with the numeral 1. The numeral 1 has a top serif to avoid this confusion.

TABLE OF CONTENTS

Section	Page
1 INTRODUCTION.....	6
1.1 CLARIFICATION OF NOTATION.....	7
1.2 GLOSSARY OF TERMS.....	7
1.3 BIBLIOGRAPHY.....	9
1.3.1 INSTALLATION INSTRUCTIONS.....	9
1.3.2 TRAINING GUIDES.....	9
1.3.3 MANUALS.....	9
1.3.4 THIRD PARTY DOCUMENTS.....	10
2 SPECIFICATION.....	11
2.1 OPERATING TEMPERATURE.....	11
2.1.1 OPTIONAL SCREEN HEATER OPERATION.....	11
2.2 REQUIREMENTS FOR UL CERTIFICATION.....	11
2.3 TERMINAL SPECIFICATION.....	12
2.4 POWER SUPPLY REQUIREMENTS.....	12
2.4.1 MODULE SUPPLY INSTRUMENTATION DISPLAY.....	12
2.5 VOLTAGE & FREQUENCY SENSING.....	13
2.6 CURRENT SENSING.....	13
2.6.1 VA RATING OF THE CTS.....	14
2.6.2 CT POLARITY.....	15
2.6.3 CT PHASING.....	15
2.6.4 CT CLASS.....	15
2.7 INPUTS.....	16
2.7.1 DIGITAL INPUTS.....	16
2.7.2 EMERGENCY STOP.....	16
2.7.3 ANALOGUE INPUTS.....	17
2.7.3.1 ANALOGUE INPUT A.....	17
2.7.3.2 ANALOGUE INPUT B.....	18
2.7.3.3 ANALOGUE INPUT C.....	18
2.7.3.4 ANALOGUE INPUT D.....	19
2.7.4 CHARGE FAIL INPUT.....	19
2.7.5 MAGNETIC PICKUP.....	20
2.8 OUTPUTS.....	20
2.8.1 DC OUTPUTS A & B (FUEL & START).....	20
2.8.2 CONFIGURABLE DC OUTPUTS C, D, E & F.....	20
2.9 COMMUNICATION PORTS.....	21
2.10 COMMUNICATION PORT USAGE.....	22
2.10.1 USB SLAVE PORT (PC CONFIGURATION).....	22
2.10.2 ECU PORT (J1939).....	23
2.10.2.1 J1939-75.....	24
2.10.3 DSENET® (EXPANSION MODULES).....	29
2.11 ADDING AN EXTERNAL SOUNDER.....	30
2.12 ACCUMULATED INSTRUMENTATION.....	31
2.13 DIMENSIONS AND MOUNTING.....	31
2.13.1 DIMENSIONS.....	31
2.13.2 PANEL CUTOUT.....	31
2.13.3 WEIGHT.....	31
2.13.4 FIXING CLIPS.....	32
2.13.5 SILICON SEALING GASKET.....	33
2.13.6 APPLICABLE STANDARDS.....	34
2.13.7 ENCLOSURE CLASSIFICATIONS.....	36
2.13.7.1 IP CLASSIFICATIONS.....	36
2.13.7.2 NEMA CLASSIFICATIONS.....	37
3 INSTALLATION.....	38
3.1 TERMINAL DESCRIPTION.....	38

3.2	CONNECTION DESCRIPTIONS	39
3.2.1	DC SUPPLY, E-STOP INPUT, DC OUTPUTS & CHARGE FAIL INPUT	39
3.2.2	ANALOGUE SENSORS, MPU & CAN.....	40
3.2.3	DSENET®	41
3.2.4	GENERATOR & MAINS VOLTAGE & FREQUENCY SENSING	41
3.2.5	CURRENT TRANSFORMERS.....	42
3.2.5.1	CT CONNECTIONS.....	42
3.2.6	DIGITAL INPUTS	43
3.2.7	USB SLAVE (PC CONFIGURATION) CONNECTOR	43
3.3	TYPICAL WIRING DIAGRAM.....	44
3.3.1	DSE6110 MKII TYPICAL WIRING DIAGRAM (3 PHASE 4 WIRE).....	45
3.3.2	DSE6120 MKII TYPICAL WIRING DIAGRAM (3 PHASE 4 WIRE).....	46
3.4	ALTERNATE TOPOLOGY WIRING DIAGRAMS	47
3.4.1	GENERATOR.....	47
3.4.2	MAINS (DSE6120 MKII ONLY)	48
3.5	EARTH SYSTEMS	49
3.5.1	NEGATIVE EARTH.....	49
3.5.2	POSITIVE EARTH.....	49
3.5.3	FLOATING EARTH	49
3.6	TYPICAL ARRANGEMENT OF DSENET®	50
4	DESCRIPTION OF CONTROLS.....	51
4.1	DSE6110 MKII.....	52
4.2	DSE6120 MKII.....	53
4.3	CONTROL PUSH-BUTTONS	54
4.4	VIEWING THE INSTRUMENT PAGES.....	57
4.4.1	STATUS	58
4.4.1.1	GENERATOR LOCKED OUT	58
4.4.1.2	WAITING FOR GENERATOR	58
4.4.1.3	ENHANCED TIER IV HOME SCREEN	59
4.4.2	ENGINE.....	60
4.4.2.1	DPF REGENERATION LAMPS	61
4.4.3	GENERATOR.....	62
4.4.4	MAINS (DSE6120 MKII ONLY)	63
4.4.5	EXPANSION.....	64
4.4.6	ALARMS.....	65
4.4.6.1	ECU ALARMS (CAN ERROR MESSAGE / DTC)	66
4.4.7	EVENT LOG.....	67
4.4.8	LCD INDICATORS.....	68
4.4.9	USER DEFINED STRINGS.....	68
4.4.10	CONFIGURABLE CAN	69
4.4.11	ABOUT	70
4.4.11.1	MODULE INFORMATION.....	70
4.4.11.2	SUPPORT STRINGS.....	70
5	OPERATION.....	71
5.1	QUICKSTART GUIDE.....	71
5.1.1	STARTING THE ENGINE	71
5.1.2	STOPPING THE ENGINE.....	72
5.2	STOP/RESET MODE	73
5.2.1	ECU OVERRIDE	73
5.3	MANUAL MODE	74
5.3.1	STARTING SEQUENCE	74
5.3.2	ENGINE RUNNING.....	75
5.3.3	STOPPING SEQUENCE.....	75
5.4	TEST MODE.....	76
5.4.1	STARTING SEQUENCE	76
5.4.2	ENGINE RUNNING.....	77
5.4.3	STOPPING SEQUENCE.....	77
5.5	AUTOMATIC MODE	78
5.5.1	WAITING IN AUTO MODE.....	78

5.5.2	STARTING SEQUENCE	79
5.5.3	ENGINE RUNNING.....	80
5.5.4	STOPPING SEQUENCE.....	80
5.6	SCHEDULER	81
5.6.1	STOP MODE.....	81
5.6.2	MANUAL MODE.....	81
5.6.3	TEST MODE.....	81
5.6.4	AUTO MODE.....	81
6	PROTECTIONS	82
6.1	ALARMS	82
6.1.1	ECU ALARMS (CAN ERROR MESSAGE / DTC).....	83
6.2	INDICATIONS	84
6.3	WARNING ALARMS.....	85
6.4	ELECTRICAL TRIP ALARMS	89
6.5	SHUTDOWN ALARMS	92
6.6	MAINTENANCE ALARMS.....	96
6.7	OVER CURRENT ALARM.....	97
6.7.1	IMMEDIATE WARNING	97
6.7.2	INVERSE DEFINITE MINIMUM TIME (IDMT) ALARM.....	98
6.7.2.1	CREATING A SPREADSHEET FOR THE OVER CURRENT IDMT CURVE.....	99
7	FRONT PANEL CONFIGURATION.....	101
7.1	MAIN CONFIGURATION EDITOR	102
7.1.1	ACCESSING THE MAIN CONFIGURATION EDITOR.....	102
7.1.2	ENTERING PIN.....	102
7.1.3	EDITING A PARAMETER	103
7.1.4	EXITING THE FRONT PANEL CONFIGURATION EDITOR	103
7.1.5	ADJUSTABLE PARAMETERS	104
7.2	'RUNNING' CONFIGURATION EDITOR.....	106
7.2.1	ACCESSING THE 'RUNNING' CONFIGURATION EDITOR	106
7.2.2	ENTERING PIN.....	106
7.2.3	EDITING A PARAMETER.....	106
7.2.4	EXITING THE 'RUNNING' CONFIGURATION EDITOR	107
7.2.5	RUNNING EDITOR PARAMETERS	107
8	COMMISSIONING	108
9	FAULT FINDING.....	109
9.1	STARTING	109
9.2	LOADING	109
9.3	ALARMS	110
9.4	COMMUNICATIONS	110
9.5	INSTRUMENTS.....	110
9.6	MISCELLANEOUS.....	111
10	MAINTENANCE, SPARES, REPAIR AND SERVICING	112
10.1	PURCHASING ADDITIONAL CONNECTOR PLUGS FROM DSE.....	112
10.1.1	PACK OF PLUGS	112
10.1.2	INDIVIDUAL PLUGS.....	112
10.2	PURCHASING ADDITIONAL FIXING CLIPS FROM DSE.....	112
10.3	PURCHASING ADDITIONAL SEALING GASKET FROM DSE	112
10.4	DSENET® EXPANSION MODULES	113
11	WARRANTY	114
12	DISPOSAL	114
12.1	WEEE (WASTE ELECTRICAL AND ELECTRONIC EQUIPMENT).....	114

1 INTRODUCTION

This document details the installation and operation requirements of the DSE6110 MKII & DSE6120 MKII modules, part of the DSEGenSet® range of products.

The manual forms part of the product and should be kept for the entire life of the product. If the product is passed or supplied to another party, ensure that this document is passed to them for reference purposes.

This is not a *controlled document*. DSE do not automatically inform on updates. Any future updates of this document are included on the DSE website at www.deepseapl.com

The DSE61xx MKII series is designed to provide differing levels of functionality across a common platform. This allows the generator OEM greater flexibility in the choice of controller to use for a specific application.

The DSE61xx MKII series module has been designed to allow the operator to start and stop the generator, and if required, transfer the load to the generator either manually or automatically. Additionally, the DSE6120 MKII automatically starts and stops the generator set depending upon the status of the mains (utility) supply.

The user also has the facility to view the system operating parameters via the text LCD display.

The DSE61xx MKII module monitors the engine, indicating the operational status and fault conditions, automatically shutting down the engine and giving a true first up fault condition of an engine failure by the text LCD display.

The powerful ARM microprocessor contained within the module allows for incorporation of a range of complex features:

Text based LCD display

True RMS Voltage

Current and Power monitoring

USB Communications

Engine parameter monitoring.

Fully configurable inputs for use as alarms or a range of different functions.

*Engine ECU interface to **electronic engines**.*

Data Logging



Using a PC and the DSE Configuration Suite software allows alteration of selected operational sequences, timers, alarms and operational sequences. Additionally, the module's integral front panel configuration editor allows adjustment of this information.

Access to critical operational sequences and timers for use by qualified engineers, can be protected by a security code. Module access can also be protected by PIN code. Selected parameters can be changed from the module's front panel.

The module is housed in a robust plastic case suitable for panel mounting. Connections to the module are via locking plug and sockets.

1.1 CLARIFICATION OF NOTATION

Clarification of notation used within this publication.

	NOTE:	Highlights an essential element of a procedure to ensure correctness.
	CAUTION!	Indicates a procedure or practice, which, if not strictly observed, could result in damage or destruction of equipment.
	WARNING!	Indicates a procedure or practice, which could result in injury to personnel or loss of life if not followed correctly.

1.2 GLOSSARY OF TERMS

Term	Description
DSE6000 MKII DSE6xxx MKII	All modules in the DSE6xxx MKII range.
DSE6100 MKII DSE61xx MKII	All modules in the DSE61xx MKII range.
DSE6110 MKII	DSE6110 MKII module/controller
DSE6120 MKII	DSE6120 MKII module/controller
CAN	Controller Area Network Vehicle standard to allow digital devices to communicate to one another.
CDMA	Code Division Multiple Access. Cell phone access used in small number of areas including parts of the USA and Australia.
CT	Current Transformer An electrical device that takes a large AC current and scales it down by a fixed ratio to a smaller current.
BMS	Building Management System A digital/computer based control system for a building's infrastructure.
DEF	Diesel Exhaust Fluid (AdBlue) A liquid used as a consumable in the SCR process to lower nitric oxide and nitrogen dioxide concentration in engine exhaust emissions.
DM1	Diagnostic Message 1 A DTC that is currently active on the engine ECU.
DM2	Diagnostic Message 2 A DTC that was previously active on the engine ECU and has been stored in the ECU's internal memory.
DPF	Diesel Particulate Filter A filter fitted to the exhaust of an engine to remove diesel particulate matter or soot from the exhaust gas.
DPTC	Diesel Particulate Temperature Controlled Filter A filter fitted to the exhaust of an engine to remove diesel particulate matter or soot from the exhaust gas which is temperature controlled.
DTC	Diagnostic Trouble Code The name for the entire fault code sent by an engine ECU.
ECU/ECM	Engine Control Unit/Management An electronic device that monitors engine parameters and regulates the fuelling.
FMI	Failure Mode Indicator A part of DTC that indicates the type of failure, e.g. high, low, open circuit etc.
GSM	Global System for Mobile communications. Cell phone technology used in most of the World.

Continued over page...

Term	Description
HEST	High Exhaust System Temperature Initiates when DPF filter is full in conjunction with an extra fuel injector in the exhaust system to burn off accumulated diesel particulate matter or soot.
HMI	Human Machine Interface A device that provides a control and visualisation interface between a human and a process or machine.
IDMT	Inverse Definite Minimum Time
MSC	Multi-Set Communication
OC	Occurrence Count A part of DTC that indicates the number of times that failure has occurred.
PGN	Parameter Group Number A CAN address for a set of parameters that relate to the same topic and share the same transmission rate.
PLC	Programmable Logic Controller A programmable digital device used to create logic for a specific purpose.
SCADA	Supervisory Control And Data Acquisition A system that operates with coded signals over communication channels to provide control and monitoring of remote equipment
SCR	Selective Catalytic Reduction A process that uses DEF with the aid of a catalyst to convert nitric oxide and nitrogen dioxide into nitrogen and water to reduce engine exhaust emission.
SIM	Subscriber Identity Module. The small card supplied by the GSM/CDMA provider that is inserted into the cell phone, GSM modem or DSEGateway device to give GSM/GPRS connection.
SMS	Short Message Service The text messaging service of mobile/cell phones.
SPN	Suspect Parameter Number A part of DTC that indicates what the failure is, e.g. oil pressure, coolant temperature, turbo pressure etc.

1.3 BIBLIOGRAPHY

This document refers to, and is referred by the following DSE publications which are obtained from the DSE website: www.deepseapl.com or by contacting DSE technical support: support@deepseapl.com.

1.3.1 INSTALLATION INSTRUCTIONS

Installation instructions are supplied with the product in the box and are intended as a 'quick start' guide only.

DSE Part	Description
053-032	DSE2548 LED Expansion Annunciator Installation Instructions
053-033	DSE2130 Input Expansion Installation Instructions
053-034	DSE2157 Output Expansion Installation Instructions
053-173	DSE6110 MKII & DSE6120 MKII Installation Instructions

1.3.2 TRAINING GUIDES

Training guides are provided as 'hand-out' sheets on specific subjects during training sessions and contain specific information regarding to that subject.

DSE Part	Description
056-005	Using CTs With DSE Products
056-010	Over Current Protection
056-022	Breaker Control
056-023	Adding New CAN Files
056-026	kW, kvar, kVA and pf.
056-029	Smoke Limiting
056-030	Module PIN Codes
056-055	Alternate Configurations
056-069	Firmware Update
056-075	Adding Language Files
056-091	Equipotential Earth Bonding
056-092	Best Practices for Wiring Resistive Sensors
056-095	Remote Start Input Functions

1.3.3 MANUALS

Product manuals are obtained from the DSE website: www.deepseapl.com or by contacting DSE technical support: support@deepseapl.com.

DSE Part	Description
057-004	Electronic Engines and DSE Wiring Guide
057-082	DSE2130 Input Expansion Operator Manual
057-083	DSE2157 Output Expansion Operator Manual
057-084	DSE2548 Annunciator Expansion Operator Manual
057-151	DSE Configuration Suite PC Software Installation & Operation Manual
057-224	DSE6110 MKII & DSE6120 MKII Configuration Suite PC Software Manual

1.3.4 THIRD PARTY DOCUMENTS

The following third party documents are also referred to:

Reference	Description
ISBN 1-55937-879-4	IEEE Std C37.2-1996 IEEE Standard Electrical Power System Device Function Numbers and Contact Designations. Institute of Electrical and Electronics Engineers Inc
ISBN 0-7506-1147-2	Diesel generator handbook. L.L.J. Mahon
ISBN 0-9625949-3-8	On-Site Power Generation. EGSA Education Committee.

2 SPECIFICATION

2.1 OPERATING TEMPERATURE

Module	Description
DSE61xx MKII	-30 °C +70 °C (-22 °F +158 °F)
Display Heater Variants	-40 °C +70 °C (-40 °F +158 °F)

2.1.1 OPTIONAL SCREEN HEATER OPERATION

Screen Heater Function	Description
Turn On When Temperature Falls Below	-10 °C (+14 °F)
Turn Off When Temperature Rises Above	-5 °C (+23 °F)

2.2 REQUIREMENTS FOR UL CERTIFICATION

	<p>WARNING! More than one live circuit exists, refer to section entitled <i>Typical Wiring Diagram</i> elsewhere in this document for more details.</p>
---	--

Specification	Description
Screw Terminal Tightening Torque	<ul style="list-style-type: none"> 4.5 lb-in (0.5 Nm)
Conductors	<ul style="list-style-type: none"> Terminals suitable for connection of conductor size 13 AWG to 20 AWG (0.5 mm² to 2.5 mm²). Conductor protection must be provided in accordance with NFPA 70, Article 240 Low voltage circuits (35 V or less) must be supplied from the engine starting battery or an isolated secondary circuit. The communication, sensor, and/or battery derived circuit conductors shall be separated and secured to maintain at least ¼" (6 mm) separation from the generator and mains connected circuit conductors unless all conductors are rated 600 V or greater.
Current Inputs	<ul style="list-style-type: none"> Must be connected through UL Listed or Recognized isolating current transformers with the secondary rating of 5 A max.
Communication Circuits	<ul style="list-style-type: none"> Must be connected to communication circuits of UL Listed equipment
DC Output Pilot Duty	<ul style="list-style-type: none"> 0.5 A
Mounting	<ul style="list-style-type: none"> Suitable for flat surface mounting in Type 1 Enclosure Type rating with surrounding air temperature -22 °F to +122 °F (-30 °C to +50 °C) Suitable for pollution degree 3 environments when voltage sensing inputs do not exceed 300 V. When used to monitor voltages over 300 V device to be installed in an unventilated or filtered ventilation enclosure to maintain a pollution degree 2 environment.
Operating Temperature	<ul style="list-style-type: none"> -22 °F to +122 °F (-30 °C to +50 °C)

2.3 TERMINAL SPECIFICATION

NOTE: For purchasing additional connector plugs from DSE, please see the section entitled Maintenance, Spares, Repair and Servicing elsewhere in this document.

Description	Specification	
Connection Type	Two part connector. <ul style="list-style-type: none"> Male part fitted to module Female part supplied in module packing case - Screw terminal, rising clamp, no internal spring. 	 <p>Example showing cable entry and screw terminals of a 10 way connector</p>
Minimum Cable Size	0.5 mm ² (AWG 20)	
Maximum Cable Size	2.5 mm ² (AWG 13)	
Tightening Torque	0.5 Nm (4.5 lb-in)	
Wire Strip Length	7 mm (9/32")	

2.4 POWER SUPPLY REQUIREMENTS

Description	Specification
Minimum Supply Voltage	8 V continuous
Cranking Dropouts	Able to survive 0 V for 100 ms providing the supply was at least 10 V before the dropout and recovers to 5 V afterwards.
Maximum Supply Voltage	35 V continuous (60 V protection)
Reverse Polarity Protection	-35 V continuous
Maximum Operating Current	100 mA at 12 V 105 mA at 24 V
Maximum Standby Current	60 mA at 12 V 55 mA at 24 V
Maximum Current When In Sleep Mode	40 mA at 12 V 35 mA at 24 V
Typical Power (Controller On, Heater Off)	1.2 W to 2.4 W
Typical Power (Controller On, Heater On)	0.7 W to 1.2 W

2.4.1 MODULE SUPPLY INSTRUMENTATION DISPLAY

Description	Specification
Range	0 V to 60 V DC (note Maximum continuous operating voltage of 35 V DC)
Resolution	0.1 V
Accuracy	1 % full scale (± 0.35 V)

2.5 VOLTAGE & FREQUENCY SENSING

Description	Specification
Measurement Type	True RMS conversion
Sample Rate	5 kHz or better
Harmonics	Up to 11 th or better
Input Impedance	450 k Ω phase to phase
Phase To Neutral	15 V (minimum required for sensing frequency) to 415 V AC (absolute maximum) Suitable for 345 V AC nominal (± 20 % for under/overvoltage detection)
Phase To Phase	25 V (minimum required for sensing frequency) to 720 V AC (absolute maximum) Suitable for 600 V AC nominal (± 20 % for under/overvoltage detection)
Common Mode Offset From Earth	100 V AC (max)
Resolution	1 V AC phase to neutral 2 V AC phase to phase
Accuracy	± 1 % of full scale phase to neutral ± 2 % of full scale phase to phase
Minimum Frequency	3.5 Hz
Maximum Frequency	75.0 Hz
Frequency Resolution	0.1 Hz
Frequency Accuracy	± 0.2 Hz

2.6 CURRENT SENSING

Description	Specification
Measurement Type	True RMS conversion
Sample Rate	5 kHz or better
Harmonics	Up to 11 th
Nominal CT Secondary Rating	5 A
Maximum Continuous Current	5 A
Overload Measurement	15 A
Absolute Maximum Overload	50 A for 1 second
Burden	0.25 VA (0.01 Ω current shunts)
Common Mode Offset	± 1 V peak plant ground to CT common terminal
Resolution	0.5 % of 5 A (± 25 mA)
Accuracy	± 1 % of Nominal (5 A) (excluding CT error) (± 50 mA)

2.6.1 VA RATING OF THE CTS

NOTE: Details for 4 mm² cables are shown for reference only. The connectors on the DSE modules are only suitable for cables up to 2.5 mm².

The VA burden of the module on the CTs is 0.25 VA. However depending upon the type and length of cabling between the CTs and the module, CTs with a greater VA rating than the module are required.

The distance between the CTs and the measuring module should be estimated and cross-referenced against the chart opposite to find the VA burden of the cable itself.

If the CTs are fitted within the alternator top box, the star point (common) of the CTs should be connected to system ground (earth) as close as possible to the CTs. This minimises the length of cable used to connect the CTs to the DSE module.

Example:

If 1.5 mm² cable is used and the distance from the CT to the measuring module is 20 m, then the burden of the cable alone is approximately 15 VA. As the burden of the DSE controller is 0.25 VA, then a CT with a rating of at least 15 VA + 0.25 VA = 15.25 VA

must be used. If 2.5 mm² cables are used over the same distance of 20 m, then the burden of the cable on the CT is approximately 7 VA. CT's required in this instance is at least 7.25 VA (7 + 0.25).

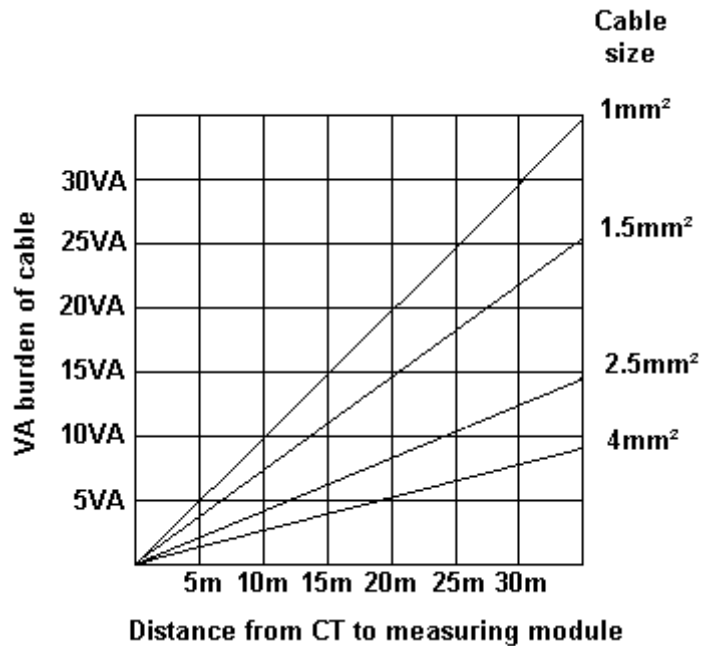

2.6.2 CT POLARITY

NOTE: Take care to ensure correct polarity of the CT primary as shown above. If in doubt, check with the CT supplier.

Take care to ensure the correct polarity of the CTs. Incorrect CT orientation leads to negative kW readings when the set is supplying power. Take note that paper stick-on labels on CTs that show the orientation are often incorrectly placed on the CT. It is more reliable to use the labelling in the case moulding as an indicator to orientation (if available).

To test orientation, run the generator in island mode (not in parallel with any other supply) and load the generator to around 10 % of the set rating. Ensure the DSE module shows positive kW for all three individual phase readings.

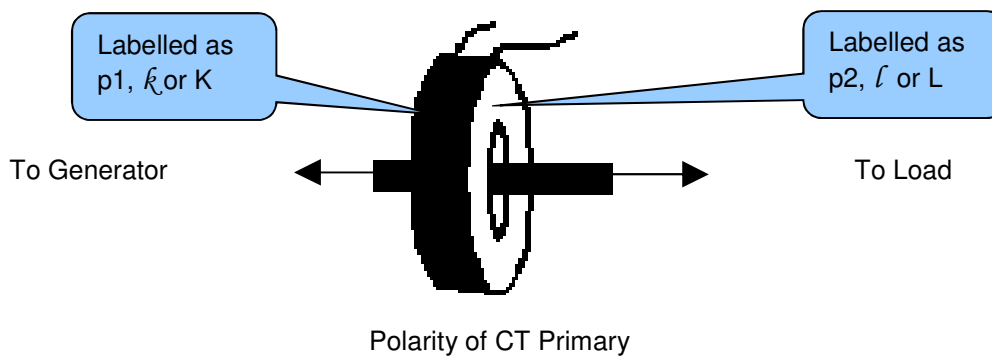

2.6.3 CT PHASING

Take particular care that the CTs are connected to the correct phases. For instance, ensure that the CT on phase 1 is connected to the terminal on the DSE module intended for connection to the CT for phase 1.

Additionally ensure that the voltage sensing for phase 1 is actually connected to generator phase 1. Incorrect connection of the phases as described above results in incorrect power factor (pf) measurements, which in turn results in incorrect kW measurements.

One way to check for this is to make use of a single-phase load. Place the load on each phase in turn, run the generator and ensure the kW value appears in the correct phase. For instance if the load is connected to phase 3, ensure the kW figure appears in phase 3 display and not in the display for phase 1 or 2.

2.6.4 CT CLASS

Ensure the correct CT type is chosen. For instance if the DSE module is providing over current protection, ensure the CT is capable of measuring the overload level required to protect against, and at the accuracy level required.

For instance, this may mean fitting a protection class CT (P15 type) to maintain high accuracy while the CT is measuring overload currents.

Conversely, if the DSE module is using the CT for instrumentation only (current protection is disabled or not fitted to the controller), then measurement class CTs can be used. Again, bear in mind the accuracy required. The DSE module is accurate to better than 1% of the full-scale current reading. To maintain this accuracy, fit a Class 0.5 or Class 1 CT.

Check with the CT manufacturer for further advice on selecting CTs Inputs

2.7 INPUTS

2.7.1 DIGITAL INPUTS

Description	Specification
Number	6 configurable digital inputs (10 when Analogue Inputs are configured as digital inputs)
Arrangement	Contact between terminal and ground
Low Level Threshold	3.2 V minimum
High Level Threshold	8.1 V maximum
Maximum Input Voltage	+60 V DC with respect to plant supply negative
Minimum Input Voltage	-24 V DC with respect to plant supply negative
Contact Wetting Current	5 mA typical
Open Circuit Voltage	12 V typical

2.7.2 EMERGENCY STOP

Description	Specification
Arrangement	Contact between terminal and module supply positive
Closed Threshold	8.1 V minimum
Open Threshold	3.2 V maximum
Maximum Input Voltage	+35 V DC with respect to plant supply negative (60 V protection for 1 minute)
Minimum Input Voltage	-24 V DC with respect to plant supply negative
Open Circuit Voltage	0 V

2.7.3 ANALOGUE INPUTS

Analogue Inputs A, B, C & D are flexible within the DSE6110 MKII & 6120 MKII modules

2.7.3.1 ANALOGUE INPUT A

Description	Specification
Input Type	Flexible: Configured for <i>Oil Sensor</i> in the DSE default configuration. Flexible Options: <i>Not used, Digital Input, Flexible Analogue & Oil Sensor</i>
Flexible Input Selection	Pressure Sensor Percentage Sensor Temperature Sensor
Flexible Measured Quantity (<i>Analogue Input A only</i>)	Current Resistive Voltage

Resistive Configuration

Description	Specification
Measurement Type	Resistance measurement by measuring voltage across sensor with a fixed current applied
Arrangement	Differential resistance measurement input
Measurement Current	15 mA \pm 10 %
Full Scale	240 Ω
Over Range / Fail	350 Ω
Resolution	1 % of display range
Accuracy	+/-2 % of full scale resistance (\pm 4.8 Ω) excluding transducer error
Max Common Mode Voltage	\pm 2 V
Display Range	0 % to 250 %, 0 °C to 250 °C (32 °F to 482 °F) or 0 bar to 17.2 bar (0 PSI to 250 PSI) subject to limits of the sensor and sensor configuration

0 V to 10 V Input Configuration

Description	Specification
Full Scale	0 V to 10 V
Resolution	1% of display range
Accuracy	+/-2% of full scale voltage (\pm 0.2 V) excluding transducer error
Max Common Mode Voltage	\pm 2 V
Display Range	0 % to 250 %, 0 °C to 250 °C (32 °F to 482 °F) or 0 bar to 17.2 bar (0 PSI to 250 PSI) subject to limits of the sensor and sensor configuration

4 mA to 20 mA Input Configuration

Description	Specification
Full Scale	0 mA to 20 mA
Resolution	1% of display range
Accuracy	+/-2% of full scale resistance (± 0.4 mA) excluding transducer error
Max Common Mode Voltage	± 2 V
Display Range	0 % to 250 %, 0 °C to 250 °C (32 °F to 482 °F) or 0 bar to 17.2 bar (0 PSI to 250 PSI) subject to limits of the sensor and sensor configuration

2.7.3.2 ANALOGUE INPUT B

Description	Specification
Input Type	Flexible: Configured for <i>Coolant Temperature</i> in the DSE default configuration. Flexible Options: <i>Not used, Digital Input, Flexible Analogue & Coolant Temperature</i>
Flexible Input Selection	Pressure Sensor Percentage Sensor Temperature Sensor
Measurement Type	Resistance measurement by measuring voltage across sensor with a fixed current applied
Arrangement	Differential resistance measurement input
Measurement Current	10 mA ± 10 %
Full Scale	480 Ω
Over Range / Fail	540 Ω
Resolution	1 % of display range
Accuracy	+/-2 % of full scale resistance (± 9.6 Ω) excluding transducer error
Max Common Mode Voltage	± 2 V
Display Range	0 % to 250 %, 0 °C to 250 °C (32 °F to 482 °F) or 0 bar to 17.2 bar (0 PSI to 250 PSI) subject to limits of the sensor and sensor configuration

2.7.3.3 ANALOGUE INPUT C

Description	Specification
Input Type	Flexible: Configured for <i>Fuel Level Sensor</i> in the DSE default configuration Flexible Options: <i>Not used, Digital Input, Flexible Analogue & Fuel Level Sensor</i>
Flexible Input Selection	Pressure Sensor Percentage Sensor Temperature Sensor
Measurement Type	Resistance measurement by measuring voltage across sensor with a fixed current applied
Arrangement	Differential resistance measurement input
Measurement Current	10 mA ± 10 %
Full Scale	480 Ω
Over Range / Fail	540 Ω
Resolution	1 % of display range
Accuracy	+/-2 % of full scale resistance (± 9.6 Ω) excluding transducer error
Max Common Mode Voltage	± 2 V
Display Range	0 % to 250 %, 0 °C to 250 °C (32 °F to 482 °F) or 0 bar to 17.2 bar (0 PSI to 250 PSI) subject to limits of the sensor and sensor configuration

2.7.3.4 ANALOGUE INPUT D

Description	Specification
Input Type	Flexible: Configured for <i>Flexible Sensor</i> , <i>Pressure Sensor</i> in the DSE default configuration. Flexible Options: <i>Not used</i> , <i>Digital Input</i> , <i>Flexible Analogue & Oil Sensor</i>
Flexible Input Selection	Pressure Sensor Percentage Sensor Temperature Sensor
Measurement Type	Resistance measurement by measuring voltage across sensor with a fixed current applied
Arrangement	Differential resistance measurement input
Measurement Current	10 mA \pm 10 %
Full Scale	480 Ω
Over Range / Fail	540 Ω
Resolution	1% of display range
Accuracy	\pm 2 % of full scale resistance (\pm 4.8 Ω) excluding transducer error
Max Common Mode Voltage	\pm 2 V
Display Range	0 % to 250 %, 0 $^{\circ}$ C to 250 $^{\circ}$ C (32 $^{\circ}$ F to 482 $^{\circ}$ F) or 0 bar to 17.2 bar (0 PSI to 250 PSI) subject to limits of the sensor and sensor configuration

2.7.4 CHARGE FAIL INPUT

The charge fail input is actually a combined input and output. Whenever the generator is required to run, the terminal provides excitation current to the charge alternator field winding.

When the charge alternator is correctly charging the battery, the voltage of the terminal is close to the plant battery supply voltage. In a failed charge situation, the voltage of this terminal is pulled down to a low voltage. It is this drop in voltage that triggers the *Charge Failure* alarm. The level at which this operates and whether this triggers a warning or shutdown alarm is configurable using the DSE Configuration Suite Software.

Description	Specification
Minimum Voltage	0 V
Maximum Voltage	35 V (plant supply)
Resolution	0.2 V
Accuracy	\pm 1 % of max measured voltage
Excitation	Active circuit constant power output
Output Power	2.5 W nominal at 12 V and 24 V
Current At 12V	210 mA
Current At 24V	105 mA

2.7.5 MAGNETIC PICKUP

**▲ NOTE: DSE supply a suitable magnetic pickup device, available in two body thread lengths:
 DSE Part number 020-012 - Magnetic Pickup probe 5/8 UNF 2 1/2" thread length
 DSE Part number 020-013 - Magnetic Pickup probe 5/8 UNF 4" thread length**

Magnetic Pickup devices can often be 'shared' between two or more devices. For example, one device can often supply the signal to both the DSE module and the engine governor. The possibility of this depends upon the amount of current that the magnetic pickup can supply.

Description	Specification
Type	Differential input
Minimum Voltage	0.5 V RMS
Maximum Voltage	60 V RMS
Max Common Mode Voltage	±2 V
Minimum Frequency	5 Hz
Maximum Frequency	20,000 Hz
Resolution	1 Hz
Accuracy	±1 %
Flywheel Teeth	10 to 500

2.8 OUTPUTS

2.8.1 DC OUTPUTS A & B (FUEL & START)

Description	Specification
Type	Normally used as Fuel & Start outputs. Fully configurable for other purposes if the module is configured to control an electronic engine.
Rating	10 A resistive for 10 secs, 5 A resistive continuous at plant supply.

2.8.2 CONFIGURABLE DC OUTPUTS C, D, E & F

Description	Specification
Type	Fully configurable, supplied from DC supply terminal 2.
Rating	2 A resistive continuous at plant supply.

2.9 COMMUNICATION PORTS

Description	Specification
USB Slave Port	Type B USB 2.0 For connection to PC running DSE Configuration Suite Max distance 6 m (20 feet)
CAN Port	<div style="border: 1px solid black; padding: 5px; margin-bottom: 5px;">  NOTE: For additional length, the DSE124 CAN Extender is available. For more information, refer to DSE Publication: 057-116 DSE124 Operator Manual </div> Engine CAN Port Standard implementation of 'Slow mode', up to 250 Kbits/s Non-Isolated. Internal Termination provided (120 Ω) Max distance 40 m (133 feet)
DSENet® (Expansion Comms) Port	Non-isolated Data connection 2 wire + common Half Duplex Baud Rate of 115 kbaud Internal termination fitted (120 Ω) Max common mode offset ±5 V Max distance 1.2 km (¾ mile)

2.10 COMMUNICATION PORT USAGE

2.10.1 USB SLAVE PORT (PC CONFIGURATION)

NOTE: DSE stock 2 m (6.5 feet) USB type A to type B cable, DSE Part Number: 016-125. Alternatively they are purchased from any PC or IT store.

NOTE: The DC supply must be connected to the module for configuration by PC.

NOTE: For further details of module configuration, refer to DSE Publication: *057-224 DSE6110 MKII & 6120 MKII Configuration Software Manual*

The USB port is provided to give a simple means of connection between a PC and the controller. Using the DSE Configuration Suite Software, the operator is then able to control the module, starting or stopping the engine, selecting operating modes, etc.

Additionally, the various operating parameters (such as coolant temperature, oil pressure, etc.) of the engine are available to be viewed or changed.

To connect a module to a PC by USB, the following items are required:

DSE6110 MKII & DSE6120 MKII Controller



DSE Configuration Suite PC Software
(Supplied on configuration suite software CD or available from www.deepseapl.com).



USB cable Type A to Type B.
(This is the same cable as often used between a PC and a USB printer)



2.10.2 ECU PORT (J1939)

▲ NOTE: For further details on connection to electronic engines, refer to DSE Publication: *057-004 Electronic Engines And DSE Wiring*

▲ NOTE: Screened 120 Ω impedance cable specified for use with CAN must be used for the CAN link.
DSE stock and supply Belden cable 9841 which is a high quality 120 Ω impedance cable suitable for CAN use (DSE part number 016-030)

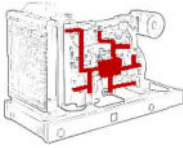

The modules are fitted with a CAN interface as standard and are capable of receiving engine data from engine ECU/ECMs compliant with the CAN J1939 standard.

ECU/ECMs monitor the engine's operating parameters such as speed, oil pressure, coolant temperature (among others) in order to closely monitor and control the engine. The industry standard communications interface (CAN) transports data gathered by the engine's ECU/ECM using the J1939 protocol. This allows engine controllers such as DSE to access these engine parameters with no physical connection to the sensor device.

The *ECU Port* is used for point-to-point cable connection of more than one device and allows for connection to CAN Scanner, PLC and CAN controllers (to name just a few devices). The operator is then able to view the various operating parameters.

2.10.2.1 J1939-75

NOTE: For further details of module configuration, refer to DSE Publication: *057-224 DSE6110 MKII & 6120 MKII Configuration Software Manual*

When the J1939-75 is enabled in the module's configuration, the module's AC measurements and alarms are sent onto the CANbus using the *ECU Port* to be received by an external monitoring device. There are two check boxes to enable each of the two parts of the interface as shown below, AC measurement and AC related alarms. The module AC alarms are translated into J1939 DM1 diagnostic messages. There are no additional display screens visible on the module when these options are selected.



Miscellaneous Options

J1939-75 Instrumentation Enable

J1939-75 Alarms Enable

The default CAN source address for additional J1939-75 messages is 44 however this may be changed by the generator supplier.

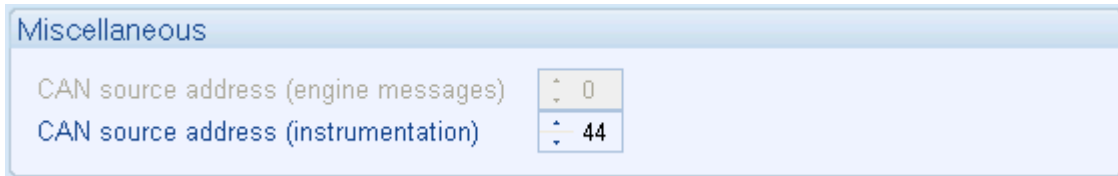

Miscellaneous

CAN source address (engine messages) 0

CAN source address (instrumentation) 44

Transmitted PGNs

PGN Message	PGN Decimal	Update Rate
ACS	64913	250 ms
DD	65276	1000 ms
DM1	65226	1000 ms
EC2	64895	Request
EEC1	61444	100 ms
EEC4	65214	Request
EFLP1	65263	500 ms
EOI	64914	250 ms
ET1	65262	1000 ms
GAAC	65030	100 ms
GC1	64915	100 ms
GPAAC	65027	100 ms
GPAACP	65026	100 ms
GPAACR	65025	100 ms
GPBAC	65024	100 ms
GPBACP	65023	100 ms
GPBACRP	65022	100 ms
GPCAC	65021	100 ms
GPCACP	65020	100 ms
GPCACR	65019	100 ms
GTACPP	64911	250 ms
GTACE	65018	100 ms
GTACER	64910	250 ms
GTACP	65029	100 ms
GTACR	65028	100 ms
HOURS	65253	Request
VEP1	65271	1000 ms
VREP	64934	100 ms

DM1 Conditions

Key	Value
Low Fault - Least Severe	17
High Fault - Least Severe	15
Low Fault - Most Severe	1
High Fault - Most Severe	0
Erratic - Incorrect Data	2

Generator Alarm Condition	SPN	Warning FMI	Shutdown FMI
Generator Average AC Frequency Under	2436	17	1
SPN Generator Average Line-Line AC RMS Voltage Over	2436	15	0
Generator Average Line-Line AC RMS Voltage Under	2440	17	1
Generator Average Line-Line AC RMS Voltage Over	2440	15	0
Generator Average Line-Neutral AC RMS Voltage Under	2444	17	1
Generator Average Line-Neutral AC RMS Voltage Over	2444	15	0
Generator Average AC RMS Current Over	2448	15	0

 **NOTE:** The availability of the Engine Alarm SPN and FMI is dependant upon the engine file selected within the DSE module's configuration. Contact DSE technical support: support@deepseapl.com for more information.

Engine Alarm Condition	SPN	Warning FMI	Shutdown FMI
Fuel Level Low	96	17	1
Oil Pressure Low (Analogue Sensor)	100	17	1
Oil Pressure Low (Digital Input)	100	17	1
Oil Pressure Sensor Fault	100	2	2
Coolant Temperature High (Analogue Sensor)	110	15	0
Coolant Temperature High (Digital Input)	110	15	0
Coolant Temperature Sensor Fault	110	2	2
Charge Alternator Failed	167	17	1
Plant Battery Voltage High	168	15	0
Plant Battery Voltage Low	168	17	1
Overspeed	190	15	0
Underspeed	190	17	1

Alternator Measurements

 **NOTE:** For further information regarding the J1939-75 interface, refer to SAE International *J1939 Digital Annex*.

PGN Message	PGN	SPN	Instrument	Scaling	Units
ACS	64913	3545	Generator Breaker Status	List 0 to 7	
		3546	Mains (Utility) Breaker Status	List 0 to 7	
GC1	64915	3567	Generator Control Not in Automatic	List 0 to 3	
GAAC	65030	2436	Generator Average AC Frequency	128	Hz
		2440	Generator Average Line Line AC RMS Voltage	1	V
		2444	Generator Average Line Neutral AC RMS Voltage	1	V
		2448	Generator Average AC RMS Current	1	A
GPAAC	65027	2437	Generator Phase A AC Frequency	128	Hz
		2441	Generator Phase A Line Line AC RMS Voltage	1	V
		2445	Generator Phase A Line Neutral AC RMS Voltage	1	V
		2449	Generator Phase A AC RMS Current	1	A
GPAACP	65026	2453	Generator Phase A Real Power	1	W
		2461	Generator Phase A Apparent Power	1	VA
GPAACR	65025	2457	Generator Phase A Reactive Power	1	var
GPBAC	65024	2438	Generator Phase B AC Frequency	128	Hz
		2442	Generator Phase B Line Line AC RMS Voltage	1	V
		2446	Generator Phase B Line Neutral AC RMS Voltage	1	V
		2450	Generator Phase B AC RMS Current	1	A
GPBACP	65023	2454	Generator Phase B Real Power	1	W
		2462	Generator Phase B Apparent Power	1	VA
GPBACRP	65022	2458	Generator Phase B Reactive Power	1	var
GPCAC	65021	2439	Generator Phase C AC Frequency	128	Hz
		2443	Generator Phase C Line Line AC RMS Voltage	1	V
		2447	Generator Phase C Line Neutral AC RMS Voltage	1	V
		2451	Generator Phase C AC RMS Current	1	A
GPCACP	65023	2455	Generator Phase C Real Power	1	W
		2463	Generator Phase C Apparent Power	1	VA
GPCACR	65019	2459	Generator Phase C Reactive Power	1	var
GTACPP	64911	3590	Generator Total Power as Percentage	1	%
GTACE	65018	2468	Generator Accumulated Energy (kWh)	1	kWh
GTACER	64910	3593	Generator Accumulated Energy (kvarh)	1	kvarh
GTACP	65029	2452	Generator Total Real Power	1	W
		2460	Generator Total Apparent Power	1	VA
GTACR	65028	2456	Generator Total Reactive Power	1	var
		2464	Generator Overall Power Factor		
		2518	Generator Overall Power Factor Lagging		Lead/Lag

Generator and Mains (Utility) Breaker Status List

PGN ACS Value	Description
0	Open
1	Closed
2 to 5	Reserved
6	Not Available
7	Reserved

Generator Control Not In Automatic Status List

PGN GC1 Value	Description
0	In Automatic
1	Not in Automatic
2	Reserved
3	Not Available

Engine Instrumentation

 **NOTE:** The availability of the Engine Instrumentation PGNs are dependant upon the engine file selected within the DSE module's configuration. Contact DSE technical support: support@deepseapl.com for more information.

PGN Message	PGN	SPN	Instrument	Scaling	Units
DD	65276	96	Fuel Level	0.4 %/bit, 0 % to 100 %	%
EC2	64895	3670	Maximum Crank Attempts Per Start Attempt	1 count/bit 0 offset	
EEC1	61444	190	Engine Speed	0.125 rpm/bit, 0 rpm to 8031.875 rpm	rpm
EEC4	65214	3671	Crank Attempt Count On Present Start Attempt	1 count/bit 0 offset	
EFL_P1	65263	100	Oil Pressure	4 kPa/bit 0 kPa to 1000 kPa	kPa
EOI	64914	3607	Emergency Stop	1 = Estop 0 = No Estop	
ET1	65262	110	Coolant Temperature	1 °C/bit, -40 °C Offset -40 °C to 210 °C	°C
HOURS	65253	247	Engine Run Hours	0.05 hours/bit, 0 offset	Hours
VEP1	65271	167	Charge Alternator Voltage	0.05 V/bit, 0 V to 3212.75 V	V
		168	Plant Battery Voltage	0.05 V/bit, 0 V to 3212.75 V	V

2.10.3 DSENET® (EXPANSION MODULES)

NOTE: For further details of module configuration, refer to DSE Publication: *057-224 DSE6110 MKII & 6120 MKII Configuration Software Manual*

NOTE: DSE6110 MKII & DSE6120 MKII modules does not support the DSE2510 or DSE2520 display modules.

NOTE: As a termination resistor is internally fitted to the controller, the controller must be the 'first' unit on the DSENet® link. A termination resistor **MUST** be fitted to the 'last' unit on the DSENet® link. For connection details, refer to section entitled *Typical Wiring Diagram* elsewhere in this document.

NOTE: DSE recommend Belden 9841 (or equivalent) cable for DSENet® communication. This is rated to a maximum cable length of 1.2 km. DSE Stock Belden 9841 cable, DSE Part Number: 016-030.

DSENet® is the interconnection cable between the host controller and the expansion module(s) and must not be connected to any device other than DSE equipment designed for connection to the DSENet®

Description	Specification
Cable Type	Two core screened and shielded twisted pair
Cable Characteristics	120 Ω Low capacitance
Recommended Cable	Belden 9841 Belden 9271
Maximum Cable Length	1200 m (¾ mile) when using Belden 9841 or direct equivalent. 600 m (656 yards) when using Belden 9271 or direct equivalent.
DSENet® Topology	"Daisy Chain" Bus with no stubs (spurs)
DSENet® Termination	120 Ω. Fitted internally to host controller. Must be fitted externally to the 'last' expansion module.
Maximum Expansion Modules	Total 6 devices made up of DSE2130 (up to 2), DSE2157 (up to 2), DSE2548 (up to 2) This gives the possibility of : Maximum 16 additional relay outputs (DSE2157) Maximum 16 additional LED indicators (DSE2548) Maximum 16 additional inputs (Can be configured as 4 digital inputs & 4 analogue resistive type inputs or 8 digital inputs when using DSE2130)

2.11 ADDING AN EXTERNAL SOUNDER

Should an external alarm or indicator be required, this can be achieved by using the DSE Configuration Suite PC software to configure an auxiliary output for *Audible Alarm*, and by configuring an auxiliary input for *Alarm Mute* (if required).

The *Audible Alarm* output activates upon a fault occurring and de-activates upon activation of mute request or after the *Audible Alarm Duration* time has ceased. The *Alarm Mute* input, internal **Lamp Test / Alarm Mute**  button and *Audible Alarm Duration* time activate 'in parallel' with each other.

Example of configuration to achieve external sounder with external alarm mute button or an automatic mute after 1 minute and 30 seconds:

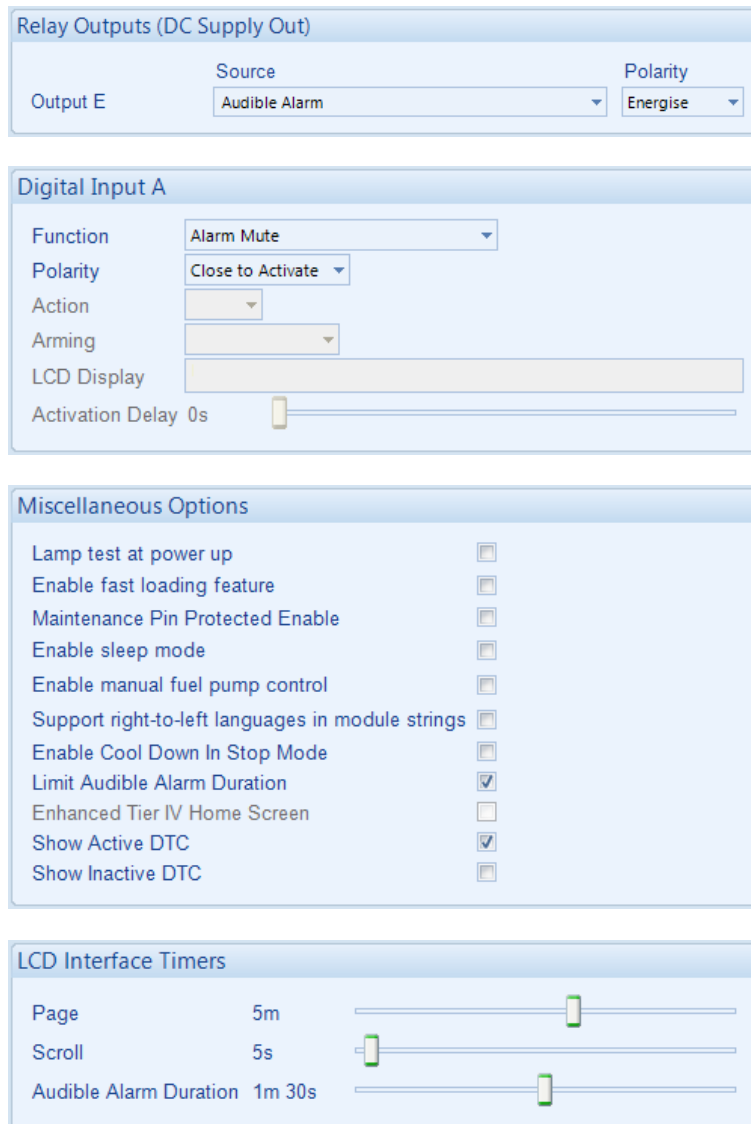

The screenshot displays four configuration panels from the DSE Configuration Suite software:

- Relay Outputs (DC Supply Out):** Shows 'Output E' configured with 'Source' set to 'Audible Alarm' and 'Polarity' set to 'Energise'.
- Digital Input A:** Shows 'Function' set to 'Alarm Mute', 'Polarity' set to 'Close to Activate', and 'Activation Delay' set to 0s.
- Miscellaneous Options:** A list of options with checkboxes. 'Limit Audible Alarm Duration' is checked, while others are unchecked.
- LCD Interface Timers:** Shows three sliders: 'Page' (5m), 'Scroll' (5s), and 'Audible Alarm Duration' (1m 30s).

2.12 ACCUMULATED INSTRUMENTATION

NOTE: When an accumulated instrumentation value exceeds the maximum number as listed below, the value is reset and begins counting from zero again.

Description	Specification
Engine Hours Run	Maximum 99999 hrs 59 minutes (Approximately 11 yrs 4 months)
Accumulated Power	999999 kWh / kVARh / kVAh

The number of logged *Engine Hours* and *Number of Starts* can be set/reset using the DSE Configuration Suite PC software. Depending upon module configuration, this may have been PIN number locked by your generator supplier

2.13 DIMENSIONS AND MOUNTING

2.13.1 DIMENSIONS

216 mm x 158 mm x 43 mm
(8.5" x 6.2" x 1.7")

2.13.2 PANEL CUTOUT

184 mm x 137 mm
(7.2" x 5.3")

2.13.3 WEIGHT

0.45 kg
(1.00 lb)

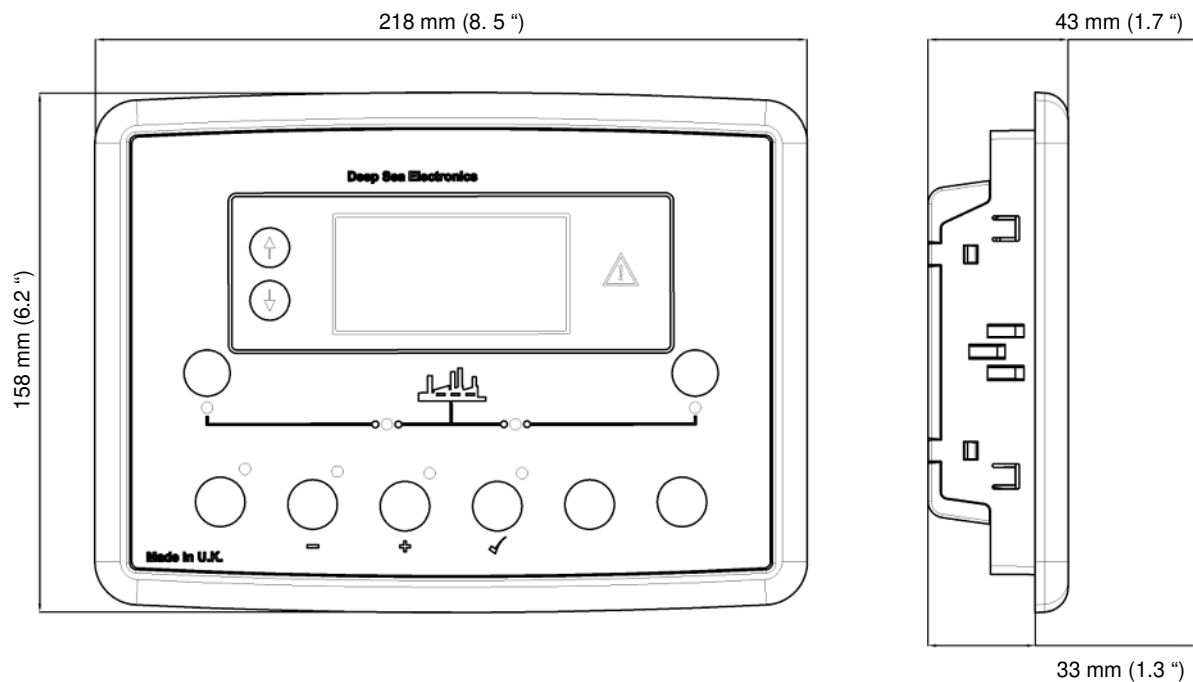

2.13.4 FIXING CLIPS

NOTE: In conditions of excessive vibration, mount the module on suitable anti-vibration mountings.

The module is held into the panel fascia using the supplied fixing clips.

- Withdraw the fixing clip screw (turn anticlockwise) until only the pointed end is protruding from the clip.
- Insert the three 'prongs' of the fixing clip into the slots in the side of the module case.
- Pull the fixing clip backwards (towards the back of the module) ensuring all three prongs of the clip are inside their allotted slots.
- Turn the fixing clip screws clockwise until they make contact with the panel fascia.
- Turn the screw a quarter of a turn to secure the module into the panel fascia. Care must be taken not to over tighten the fixing clip screws.

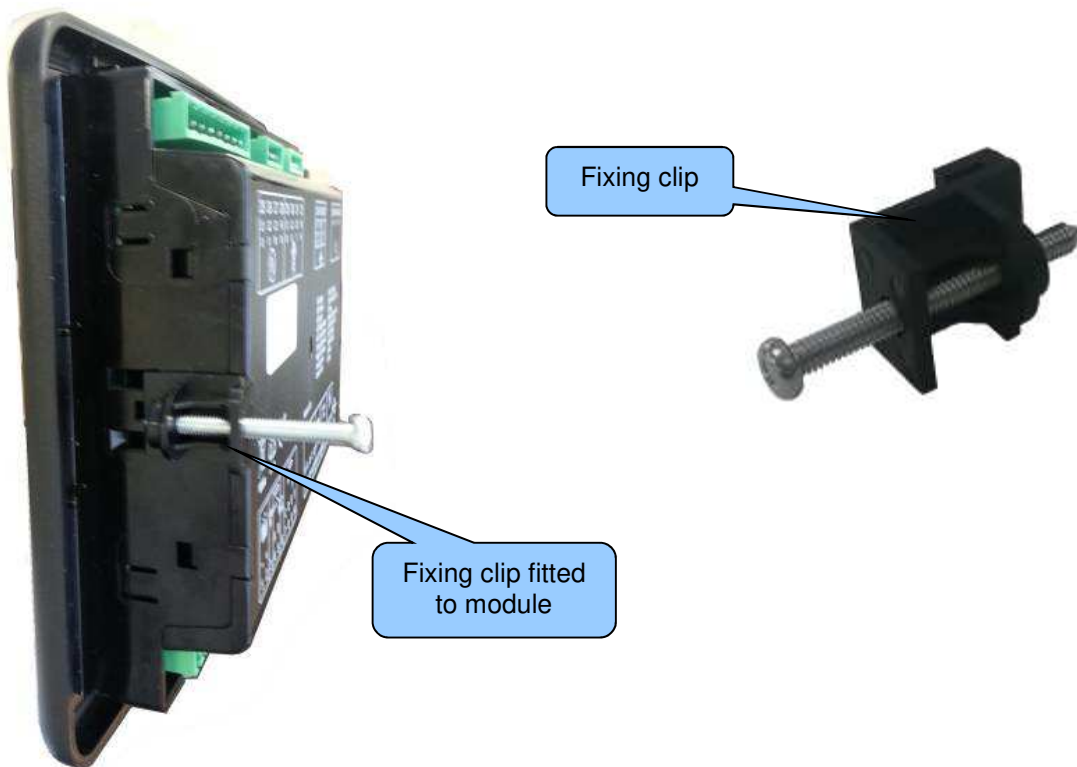

2.13.5 SILICON SEALING GASKET

NOTE: For purchasing a silicon gasket from DSE, see the section entitled **Maintenance, Spares, Repair and Servicing** elsewhere in this document.

The optional silicon gasket provides improved sealing between module and the panel fascia. The gasket is fitted to the module before installation into the panel fascia. Take care to ensure the gasket is correctly fitted to the module to maintain the integrity of the seal.

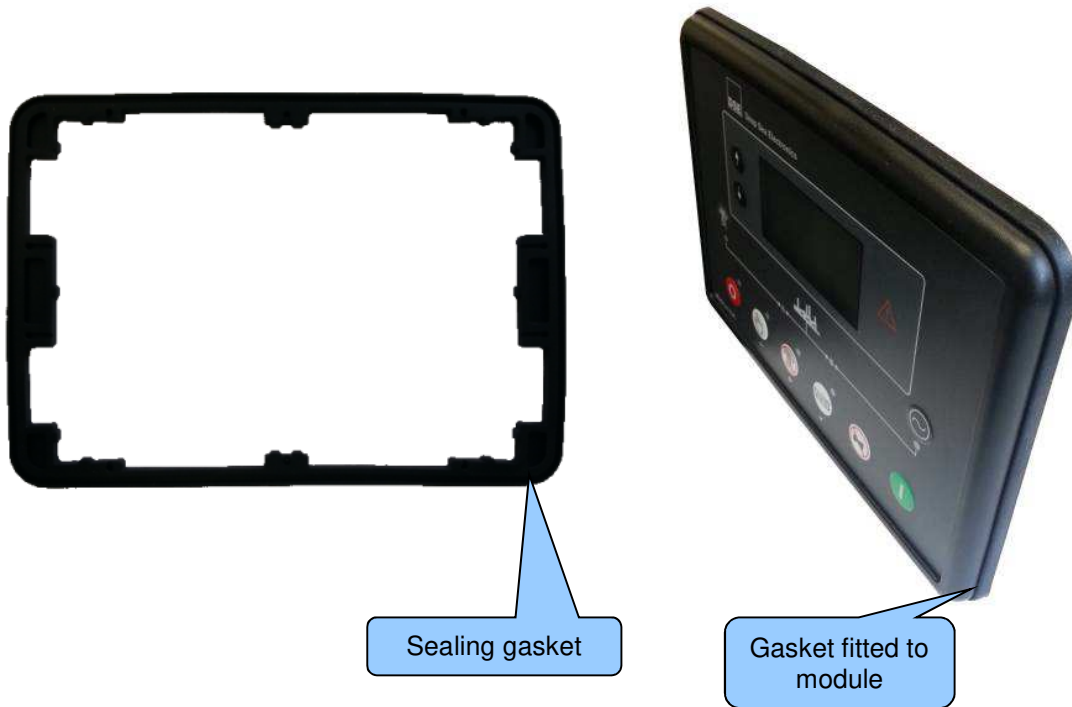

2.13.6 APPLICABLE STANDARDS

Standard	Description
BS 4884-1	This document conforms to BS4884-1 1992 Specification for presentation of essential information.
BS 4884-2	This document conforms to BS4884-2 1993 Guide to content
BS 4884-3	This document conforms to BS4884-3 1993 Guide to presentation
BS EN 60068-2-1 (Minimum temperature)	-30 °C (-22 °F)
BS EN 60068-2-2 (Maximum temperature)	+70 °C (158 °F)
BS EN 60950	Safety of information technology equipment, including electrical business equipment
BS EN 61000-6-2	EMC Generic Immunity Standard (Industrial)
BS EN 61000-6-4	EMC Generic Emission Standard (Industrial)
BS EN 60529 (Degrees of protection provided by enclosures)	IP65 (front of module when installed into the control panel with the optional sealing gasket) IP42 (front of module when installed into the control panel WITHOUT being sealed to the panel)
UL508 NEMA rating (Approximate)	12 (Front of module when installed into the control panel with the optional sealing gasket). 2 (Front of module when installed into the control panel WITHOUT being sealed to the panel)
IEEE C37.2 (Standard Electrical Power System Device Function Numbers and Contact Designations)	<p>Under the scope of IEEE 37.2, <i>function numbers can also be used to represent functions in microprocessor devices and software programs.</i> The controller is device number 11L-8000 (Multifunction device protecting Line (generator) –module).</p> <p>As the module is configurable by the generator OEM, the functions covered by the module vary. Under the module's factory configuration, the device numbers included within the module are :</p> <ul style="list-style-type: none"> 2 – Time Delay Starting Or Closing Relay 3 – Checking Or Interlocking Relay 5 – Stopping Device 6 – Starting Circuit Breaker 8 – Control Power Disconnecting Device 10 – Unit Sequence Switch 11 – Multifunction Device 12 – Overspeed Device 14 – Underspeed Device 23 – Temperature Control Device 26 – Apparatus Thermal Device 27AC – AC Undervoltage Relay 27DC – DC Undervoltage Relay 29 – Isolating Contactor Or Switch 30 – Annunciator Relay 31 – Separate Excitation Device 42 – Running Circuit Breaker

Continued overleaf...

Specification

Standard	Description
IEEE C37.2 (Standard Electrical Power System Device Function Numbers and Contact Designations)	Continued... 50 – Instantaneous Overcurrent Relay 51 – AC Time Overcurrent Relay 52 – AC Circuit Breaker 53 – Exciter Or DC Generator Relay 54 – Turning Gear Engaging Device 59AC – AC Overvoltage Relay 59DC – DC Overvoltage Relay 62 – Time Delay Stopping Or Opening Relay 63 – Pressure Switch 71 – Level Switch 74 – Alarm Relay 81 – Frequency Relay 83 – Automatic Selective Control Or Transfer Relay 86 – Lockout Relay

In line with our policy of continual development, Deep Sea Electronics, reserve the right to change specification without notice.

2.13.7 ENCLOSURE CLASSIFICATIONS

2.13.7.1 IP CLASSIFICATIONS

The modules specification under BS EN 60529 Degrees of protection provided by enclosures

IP65 (Front of module when module is installed into the control panel with the optional sealing gasket).

IP42 (front of module when module is installed into the control panel WITHOUT being sealed to the panel)

First Digit	Second Digit
Protection against contact and ingress of solid objects	Protection against ingress of water
0 No protection	0 No protection
1 Protected against ingress solid objects with a diameter of more than 50 mm. No protection against deliberate access, e.g. with a hand, but large surfaces of the body are prevented from approach.	1 Protection against dripping water falling vertically. No harmful effect must be produced (vertically falling drops).
2 Protected against penetration by solid objects with a diameter of more than 12 mm. Fingers or similar objects prevented from approach.	2 Protection against dripping water falling vertically. There must be no harmful effect when the equipment (enclosure) is tilted at an angle up to 15° from its normal position (drops falling at an angle).
3 Protected against ingress of solid objects with a diameter of more than 2.5 mm. Tools, wires etc. with a thickness of more than 2.5 mm are prevented from approach.	3 Protection against water falling at any angle up to 60° from the vertical. There must be no harmful effect (spray water).
4 Protected against ingress of solid objects with a diameter of more than 1 mm. Tools, wires etc. with a thickness of more than 1 mm are prevented from approach.	4 Protection against water splashed against the equipment (enclosure) from any direction. There must be no harmful effect (splashing water).
5 Protected against harmful dust deposits. Ingress of dust is not totally prevented but the dust must not enter in sufficient quantity to interface with satisfactory operation of the equipment. Complete protection against contact.	5 Protection against water projected from a nozzle against the equipment (enclosure) from any direction. There must be no harmful effect (water jet).
6 Protection against ingress of dust (dust tight). Complete protection against contact.	6 Protection against heavy seas or powerful water jets. Water must not enter the equipment (enclosure) in harmful quantities (splashing over).

2.13.7.2 NEMA CLASSIFICATIONS

▲ NOTE: There is no direct equivalence between IP / NEMA ratings. IP figures shown are approximate only.

12 (Front of module when module is installed into the control panel with the optional sealing gasket).
2 (Front of module when module is installed into the control panel WITHOUT being sealed to the panel)

1 IP30	Provides a degree of protection against contact with the enclosure equipment and against a limited amount of falling dirt.
2 IP31	Provides a degree of protection against limited amounts of falling water and dirt.
3 IP64	Provides a degree of protection against windblown dust, rain and sleet; undamaged by the formation of ice on the enclosure.
3R IP32	Provides a degree of protection against rain and sleet;; undamaged by the formation of ice on the enclosure.
4 (X) IP66	Provides a degree of protection against splashing water, windblown dust and rain, hose directed water; undamaged by the formation of ice on the enclosure. (Resist corrosion).
12/12K IP65	Provides a degree of protection against dust, falling dirt and dripping non corrosive liquids.
13 IP65	Provides a degree of protection against dust and spraying of water, oil and non corrosive coolants.

3 INSTALLATION

The module is designed to be mounted on the panel fascia. For dimension and mounting details, see the section entitled *Specification, Dimension and mounting* elsewhere in this document.

3.1 TERMINAL DESCRIPTION

NOTE: Availability of some terminals depends upon module version. Full details are given in the section entitled *Terminal Description* elsewhere in this manual.

To aid user connection, icons are used on the rear of the module to help identify terminal functions. An example of this is shown below.

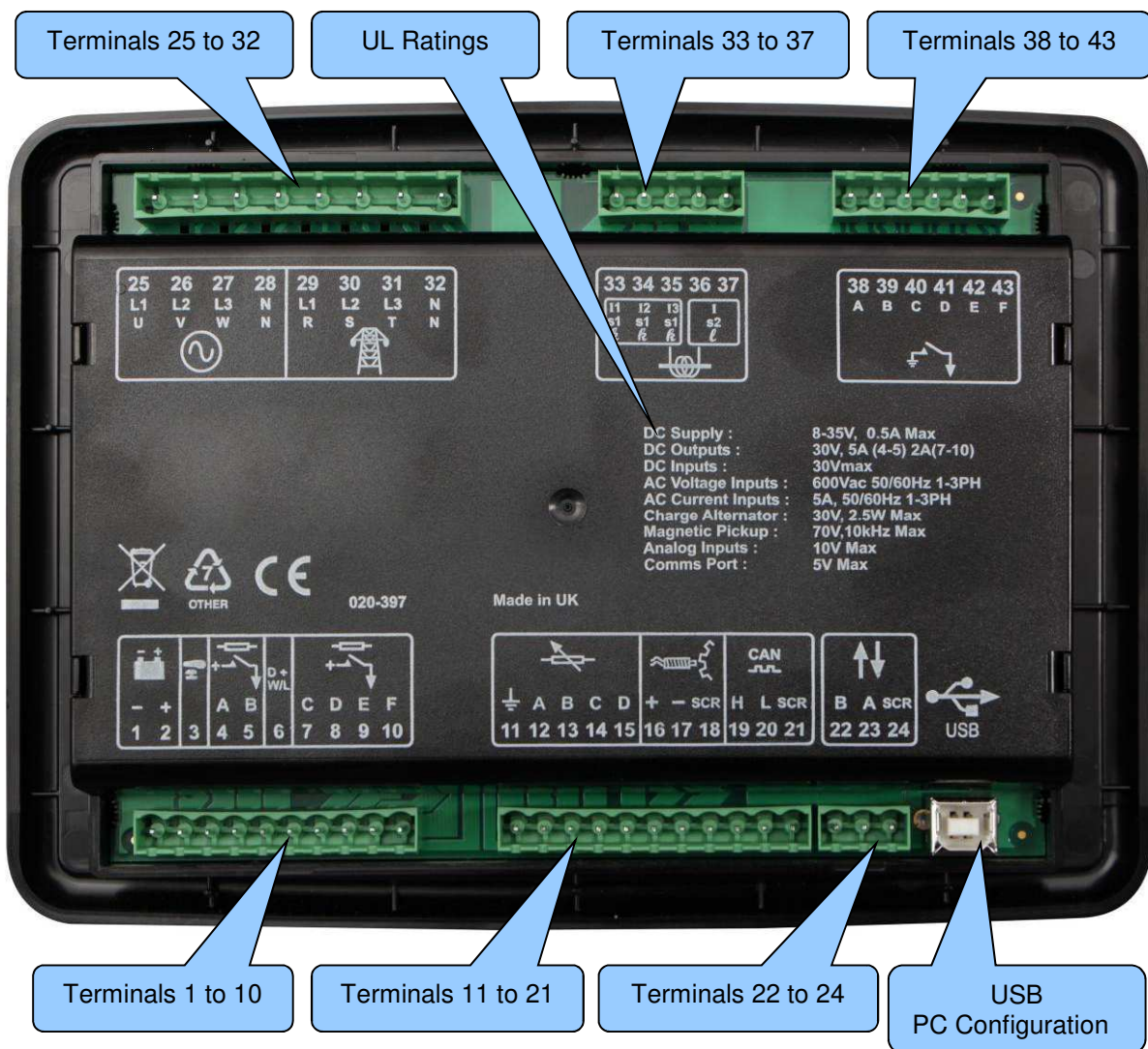





3.2 CONNECTION DESCRIPTIONS

3.2.1 DC SUPPLY, E-STOP INPUT, DC OUTPUTS & CHARGE FAIL INPUT

NOTE: When the module is configured for operation with an electronic engine, FUEL and START output requirements may be different. For further details on connection to electronic engines, refer to DSE Publication: *057-004 Electronic Engines And DSE Wiring*

NOTE: For further details of module configuration, refer to DSE Publication: *057-224 DSE6110 MKII & 6120 MKII Configuration Software Manual.*

	Pin No	Description	Cable Size	Notes
	1	DC Plant Supply Input (Negative)	2.5 mm ² AWG 13	Connect to ground where applicable.
	2	DC Plant Supply Input (Positive)	2.5 mm ² AWG 13	Supplies the module and DC Outputs C, D, E & F
	3	Emergency Stop Input	2.5 mm ² AWG 13	Plant Supply Positive. Supplies DC Outputs A & B.
	4	DC Output A (FUEL)	2.5 mm ² AWG 13	Plant Supply Positive from terminal 3. 10 A for 10 seconds, 5 A resistive continuous. Fixed as fuel relay if electronic engine is not configured.
	5	DC Output B (START)	2.5 mm ² AWG 13	Plant Supply Positive from terminal 3. 10 A for 10 seconds, 5 A resistive continuous Fixed as start relay if electronic engine is not configured.
D+ W/L	6	Charge Fail / Excite	2.5 mm ² AWG 13	Do not connect to ground (battery negative). If charge alternator is not fitted, leave this terminal disconnected.
	7	DC Output C	1.0 mm ² AWG 18	Plant Supply Positive from terminal 2. 2 A DC rated.
	8	DC Output D	1.0 mm ² AWG 18	Plant Supply Positive from terminal 2. 2 A DC rated.
	9	DC Output E	1.0 mm ² AWG 18	Plant Supply Positive from terminal 2. 2 A DC rated.
	10	DC Output F	1.0 mm ² AWG 18	Plant Supply Positive from terminal 2. 2 A DC rated.

3.2.2 ANALOGUE SENSORS, MPU & CAN



NOTE: For further details of module configuration, refer to DSE Publication: *057-224 DSE6110 MKII & 6120 MKII Configuration Software Manual*.

NOTE: It is VERY important that terminal 11 (sensor common) is soundly connected to an earth point on the ENGINE BLOCK, not within the control panel, and must be a sound electrical connection to the sensor bodies. This connection **MUST NOT** be used to provide an earth connection for other terminals or devices. The simplest way to achieve this is to run a **SEPARATE** earth connection from the system earth star point, to terminal 11 directly, and not use this earth for other connections.

NOTE: If you use PTFE insulating tape on the sensor thread when using earth return sensors, ensure you do not insulate the entire thread, as this prevents the sensor body from being earthed via the engine block.

NOTE: For further details on connection to electronic engines, refer to DSE Publication: *057-004 Electronic Engines And DSE Wiring*

NOTE: Screened 120 Ω impedance cable specified for use with CAN must be used for the CAN link.
DSE stock and supply Belden cable 9841 which is a high quality 120 Ω impedance cable suitable for CAN use (DSE part number 016-030)

	Pin No	Description	Cable Size	Notes
	11	Sensor Common Return	0.5 mm ² AWG 20	Ground Return Feed For Sensors
	12	Analogue Sensor Input A	0.5 mm ² AWG 20	Connect To Oil Pressure Sensor
	13	Analogue Sensor Input B	0.5mm ² AWG 20	Connect To Coolant Temperature Sensor
	14	Analogue Sensor Input C	0.5 mm ² AWG 20	Connect To Fuel Level Sensor
	15	Analogue Sensor Input D	0.5 mm ² AWG 20	Connect To Additional Sensor (User Configurable)
	16	Magnetic Pickup Positive	0.5 mm ² AWG 20	Connect To Magnetic Pickup Device
	17	Magnetic Pickup Negative	0.5 mm ² AWG 20	Connect To Magnetic Pickup Device
	18	Magnetic Pickup Screen	Shield	Connect To Ground At One End Only
	19	CAN Port H	0.5 mm ² AWG 20	Use Only 120 Ω CAN Approved Cable
	20	CAN Port L	0.5 mm ² AWG 20	Use Only 120 Ω CAN Approved Cable
	21	CAN Port Screen	Shield	Use Only 120 Ω CAN Approved Cable

3.2.3 DSENET®

NOTE: For further details of module configuration, refer to DSE Publication: *057-224 DSE6110 MKII & 6120 MKII Configuration Software Manual*.

NOTE: As a termination resistor is internally fitted to the controller, the controller must be the 'first' unit on the DSENet link. A termination resistor **MUST** be fitted to the 'last' unit on the DSENet® link. For connection details, refer to section entitled *Typical Wiring Diagram* elsewhere in this document.

	Pin No	Description	Cable Size	Notes
↑ ↓	22	DSENet® Expansion B	0.5 mm ² AWG 20	Use only 120 Ω CAN or RS485 approved cable
	23	DSENet® Expansion A	0.5 mm ² AWG 20	Use only 120 Ω CAN or RS485 approved cable
	24	DSENet® Expansion Screen	Shield	Use only 120 Ω CAN or RS485 approved cable

3.2.4 GENERATOR & MAINS VOLTAGE & FREQUENCY SENSING

NOTE: Terminals 29 to 32 not fitted to DSE6110 MKII

NOTE: The below table describes connections to a three phase, four wire alternator. For alternative wiring topologies, see the section entitled *Alternate Topology Wiring Diagrams* elsewhere in this document.

	Pin No	Description	Cable Size	Notes
⊜	25	Generator L1 (U) Voltage Sensing	1.0 mm ² AWG 18	Connect to generator L1 (U) output (AC) (Recommend 2 A fuse)
	26	Generator L2 (V) Voltage Sensing	1.0 mm ² AWG 18	Connect to generator L2 (V) output (AC) (Recommend 2 A fuse)
	27	Generator L3 (W) Voltage Sensing	1.0 mm ² AWG 18	Connect to generator L3 (W) output (AC) (Recommend 2 A fuse)
	28	Generator Neutral (N) Input	1.0 mm ² AWG 18	Connect to generator Neutral terminal (AC)
⚡	29	Mains L1 (R) Voltage Sensing	1.0 mm ² AWG 18	Connect to mains L1 (R) output (AC) (Recommend 2 A fuse)
	30	Mains L2 (S) Voltage Sensing	1.0 mm ² AWG 18	Connect to mains L2 (S) output (AC) (Recommend 2 A fuse)
	31	Mains L3 (T) Voltage Sensing	1.0 mm ² AWG 18	Connect to mains L3 (T) output (AC) (Recommend 2 A fuse)
	32	Mains Neutral (N) Input	1.0 mm ² AWG 18	Connect to Mains Neutral terminal (AC)

3.2.5 CURRENT TRANSFORMERS

 **WARNING!** Do not disconnect this plug when the CTs are carrying current. Disconnection open circuits the secondary of the C.T.'s and dangerous voltages may then develop. Always ensure the CTs are not carrying current and the CTs are short circuit connected before making or breaking connections to the module.

 **NOTE:** The module has a burden of 0.5VA on the CT. Ensure the CT is rated for the burden of the controller, the cable length being used and any other equipment sharing the CT. If in doubt, consult your CT supplier.

	Pin No	Description	Cable Size	Notes
	33	CT Secondary for L1	2.5 mm ² AWG 13	Connect to s1 secondary of L1 monitoring CT
	34	CT Secondary for L2	2.5 mm ² AWG 13	Connect to s1 secondary of L2 monitoring CT
	35	CT Secondary for L3	2.5 mm ² AWG 13	Connect to s1 secondary of L3 monitoring CT
	36	CT Common	2.5 mm ² AWG 13	Connect to s2 secondary of L1, L2 & L3 monitoring CTs and ground
	37			

3.2.5.1 CT CONNECTIONS

p1, κ or K is the primary of the CT that 'points' towards the Generator

p2, ℓ or L is the primary of the CT that 'points' towards the Load

s1 is the secondary of the CT that connects to the DSE Module's input for the CT measuring

s2 is the secondary of the CT that should be commoned with the s2 connections of all the other CTs and connected to the CT common terminal of the module.

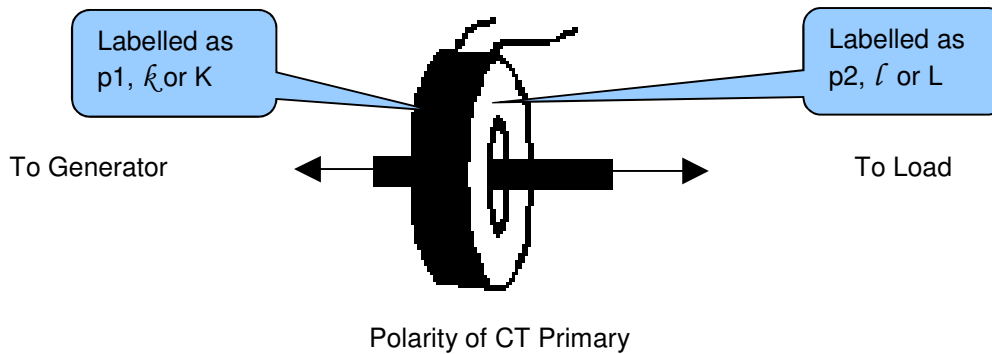

3.2.6 DIGITAL INPUTS

NOTE: For further details of module configuration, refer to DSE Publication: *057-224 DSE6110 MKII & 6120 MKII Configuration Software Manual.*



	Pin No	Description	Cable Size	Notes
	38	Configurable Digital Input A	0.5 mm ² AWG 20	Switch To Negative
	39	Configurable Digital Input B	0.5 mm ² AWG 20	Switch To Negative
	40	Configurable Digital Input C	0.5 mm ² AWG 20	Switch To Negative
	41	Configurable Digital Input D	0.5 mm ² AWG 20	Switch To Negative
	42	Configurable Digital Input E	0.5 mm ² AWG 20	Switch To Negative
	43	Configurable Digital Input F	0.5 mm ² AWG 20	Switch To Negative

3.2.7 USB SLAVE (PC CONFIGURATION) CONNECTOR

NOTE: The USB connection cable between the PC and the module must not be extended beyond 5 m (5.5 yards). For distances over 5 m, it is possible to use a third party USB extender. Typically, they extend USB up to 50 m. The supply and support of this type of equipment is outside the scope of Deep Sea Electronics PLC.

CAUTION! Care must be taken not to overload the PC's USB system by connecting more than the recommended number of USB devices to the PC. For further information, consult your PC supplier.

NOTE: For further details of module configuration, refer to DSE Publication: *057-224 DSE6110 MKII & 6120 MKII Configuration Software Manual.*

	Description	Cable Size	Notes
 	Socket for connection to PC with DSE Configuration Suite Software	0.5 mm ² AWG 20	This is a standard USB type A to type B connector. 

3.3 TYPICAL WIRING DIAGRAM

As every system has different requirements, these diagrams show only a TYPICAL system and do not intend to show a complete system.

Genset manufacturers and panel builders may use these diagrams as a starting point; however, you are referred to the completed system diagram provided by your system manufacturer for complete wiring detail.

Further wiring suggestions are available in the following DSE publications, available at www.deepseapl.com to website members.

DSE Part	Description
056-022	Breaker Control (Training guide)
057-004	Electronic Engines and DSE Wiring

3.3.1 DSE6110 MKII TYPICAL WIRING DIAGRAM (3 PHASE 4 WIRE)

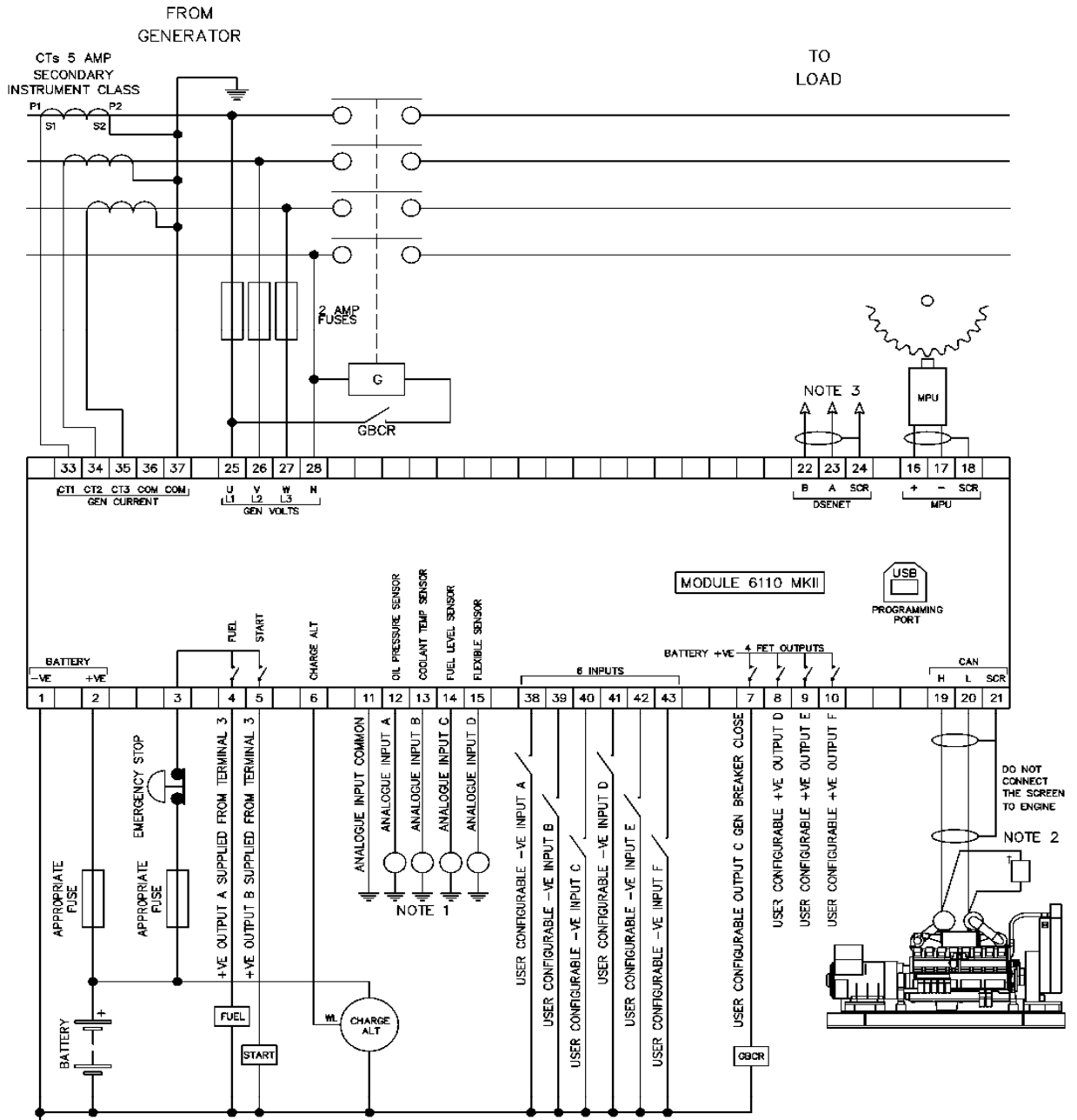

BATTERY NEGATIVE MUST BE GROUNDED

NOTE 1. THESE GROUND CONNECTIONS MUST BE ON THE ENGINE BLOCK, AND MUST BE TO THE SENSOR BODIES.

NOTE 2. 120 R TERMINATING RESISTOR MAY BE REQUIRED EXTERNALLY, SEE ENGINE MANUFACTURERS LITERATURE.

NOTE 3. MUST BE FITTED AS FIRST OR LAST UNIT WITH NO TERMINATION RESISTOR. THE SUBSEQUENT FIRST OR LAST UNIT ON DSENET MUST BE FITTED WITH A 120 OHM TERMINATION RESISTOR ACROSS TERMINALS A AND B.

3.3.2 DSE6120 MKII TYPICAL WIRING DIAGRAM (3 PHASE 4 WIRE)

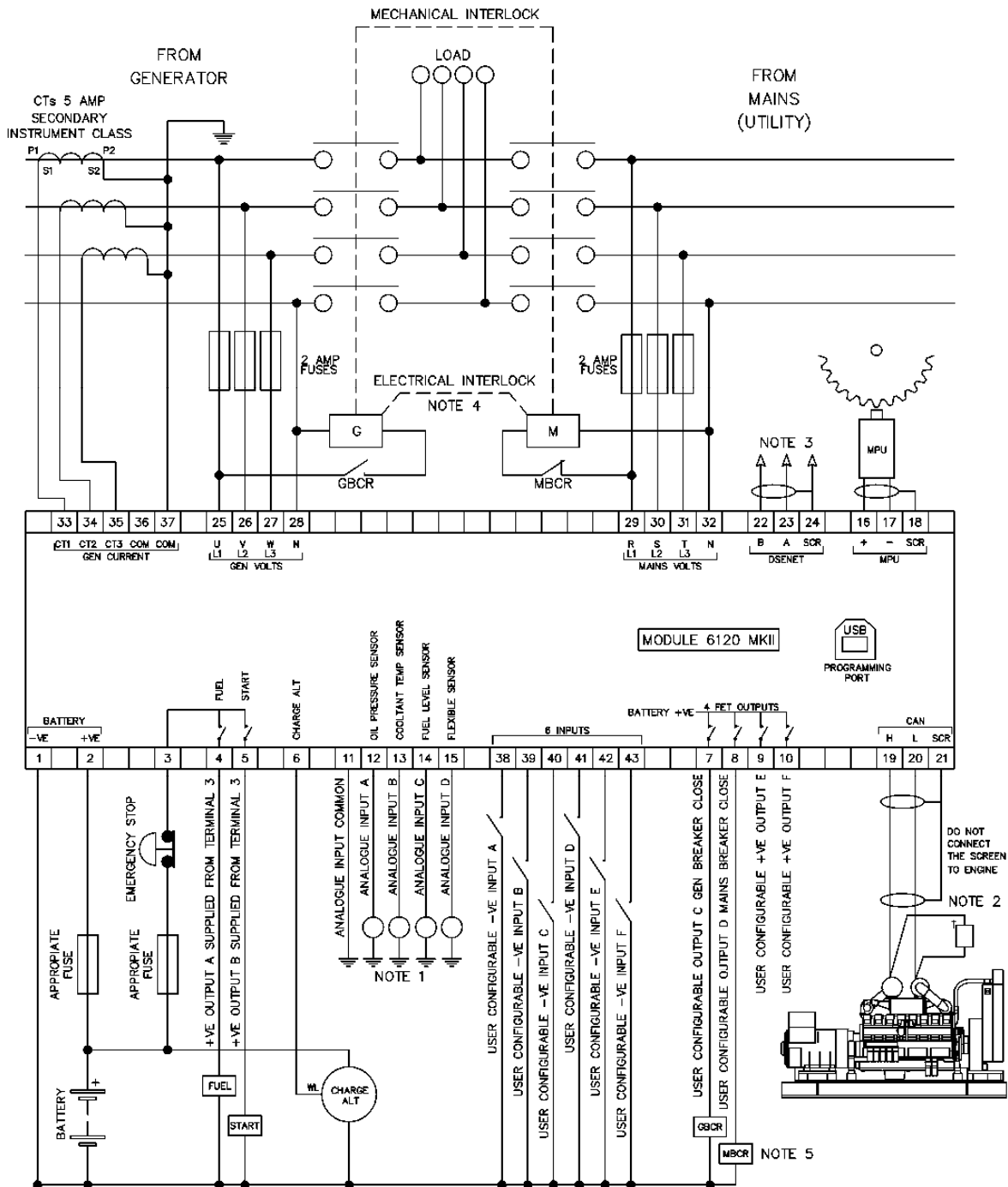

- BATTERY NEGATIVE MUST BE GROUNDED
- NOTE 1. THESE GROUND CONNECTIONS MUST BE ON THE ENGINE BLOCK, AND MUST BE TO THE SENSOR BODIES.
- NOTE 2. 120 R TERMINATING RESISTOR MAY BE REQUIRED EXTERNALLY, SEE ENGINE MANUFACTURERS LITERATURE.
- NOTE 3. MUST BE FITTED AS FIRST OR LAST UNIT ON DSENET WITH NO TERMINATION RESISTOR. THE SUBSEQUENT FIRST OR LAST UNIT ON DSENET MUST BE FITTED WITH A 120 OHM TERMINATION RESISTOR ACROSS TERMINALS A AND B.
- NOTE 4. IT IS RECOMMENDED THAT THE GENERATOR AND MAINS SWITCHING DEVICES ARE MECHANICALLY AND ELECTRICALLY INTERLOCKED.
- NOTE 5. MAINS BREAKER CLOSED OUTPUT SHOULD BE CONFIGURED FOR DE-ENERGISE CLOSE MAINS, AND USE THE NORMALLY CLOSED CONTACTS OF MBCR

3.4 ALTERNATE TOPOLOGY WIRING DIAGRAMS

3.4.1 GENERATOR

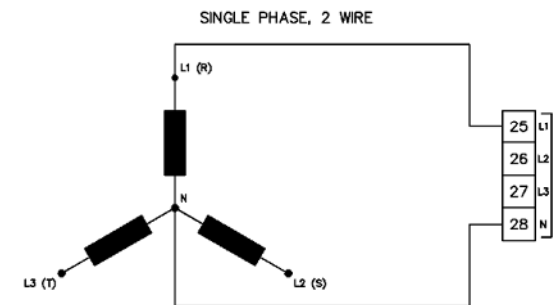
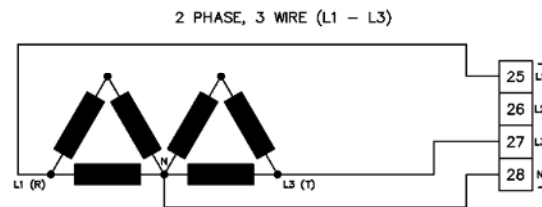
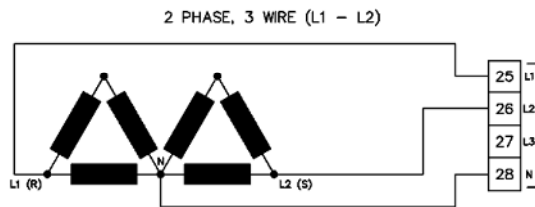
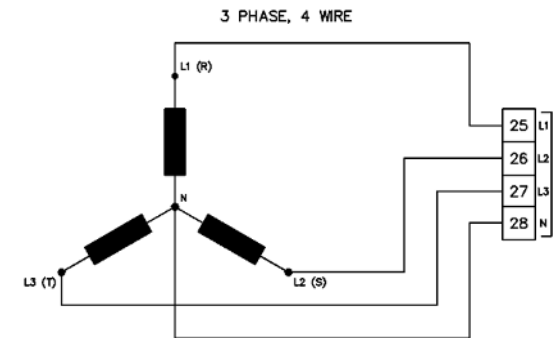
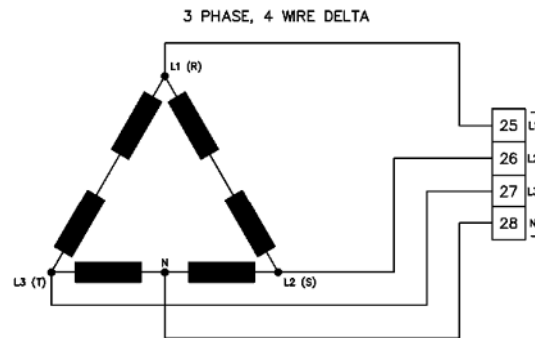
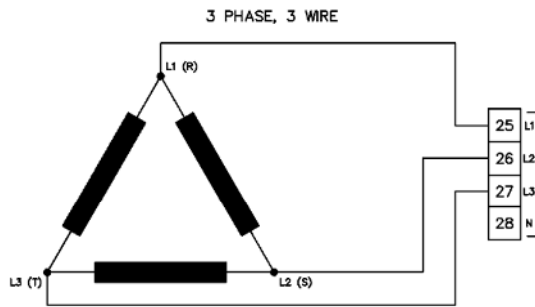

Installation

3.4.2 MAINS (DSE6120 MKII ONLY)

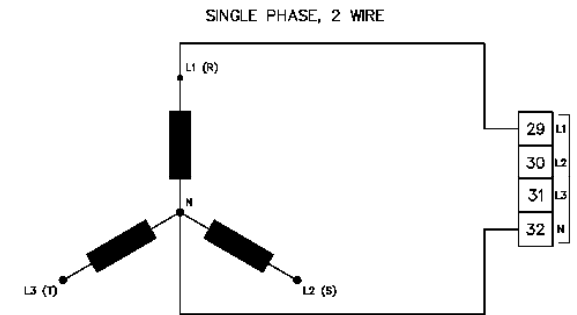
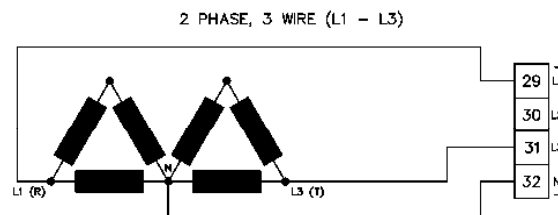
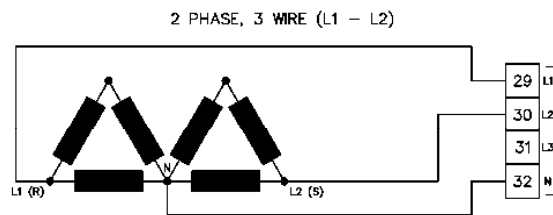
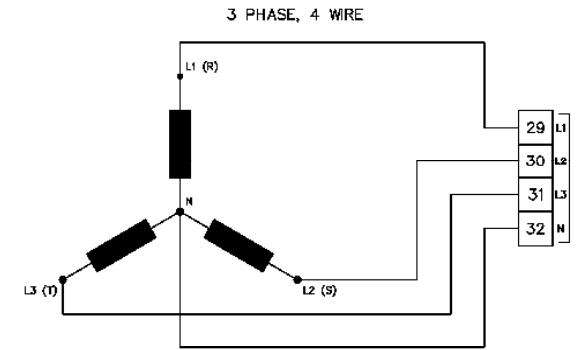
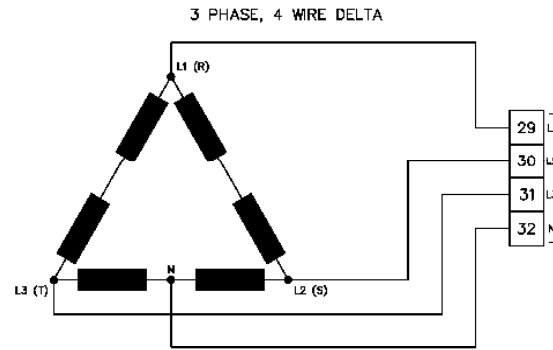
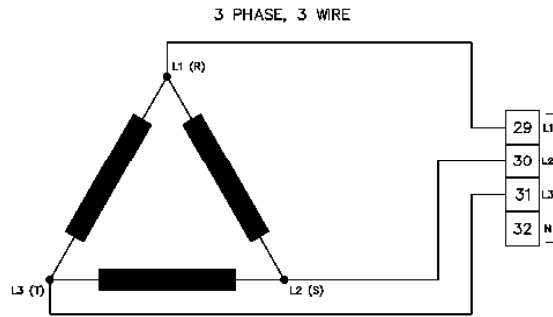

3.5 EARTH SYSTEMS

3.5.1 NEGATIVE EARTH

The typical wiring diagrams located within this document show connections for a negative earth system (the battery negative connects to Earth)

3.5.2 POSITIVE EARTH

When using a DSE module with a Positive Earth System (the battery positive connects to Earth), the following points must be followed:

- Follow the typical wiring diagram as normal for all sections EXCEPT the earth points
- All points shown as Earth on the typical wiring diagram should connect to BATTERY NEGATIVE (not earth).

3.5.3 FLOATING EARTH

Where neither the battery positive nor battery negative terminals are connected to earth the following points must to be followed

- Follow the typical wiring diagram as normal for all sections EXCEPT the earth points
- All points shown as Earth on the typical wiring diagram should connect to BATTERY NEGATIVE (not earth).

3.6 TYPICAL ARRANGEMENT OF DSENET®

NOTE: For further details of module configuration, refer to DSE Publication: 057-224 *DSE6110 MKII & DSE6120 MKII Configuration Software Manual.*

NOTE: Screened 120 Ω impedance cable specified for use with CAN must be used for the DSEnet® (RS485) connection.

DSE stock and supply Belden cable 9841 which is a high quality 120Ω impedance cable suitable for DSEnet® use (DSE part number 016-030)

Six (6) devices can be connected to the DSEnet®, made up of the following devices :

Device	Maximum Number Supported
DSE2130 Input Expansion	2
DSE2157 Relay Output Expansion	2
DSE2548 LED Expansion	2

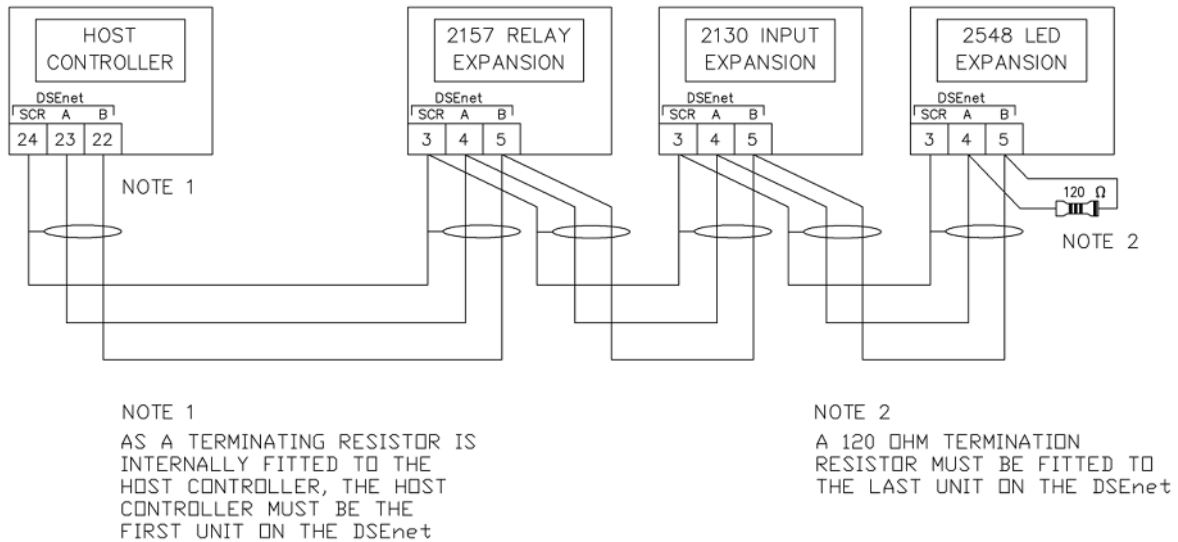

4 DESCRIPTION OF CONTROLS



CAUTION: The module may instruct an engine start event due to external influences. Therefore, it is possible for the engine to start at any time without warning. Prior to performing any maintenance on the system, it is recommended that steps are taken to remove the battery and isolate supplies.



NOTE: The following descriptions detail the sequences followed by a module containing the standard 'factory configuration'. Always refer to your configuration source for the exact sequences and timers observed by any particular module in the field.

Control of the module is via push buttons mounted on the front of the module with

Stop/Reset Mode , **Manual Mode** , **Test Mode**  (DSE6120 MKII Only), **Auto Mode** 

and **Start**  functions. For normal operation, these are the only controls which need to be operated. Details of their operation are provided later in this document.

4.1 DSE6110 MKII

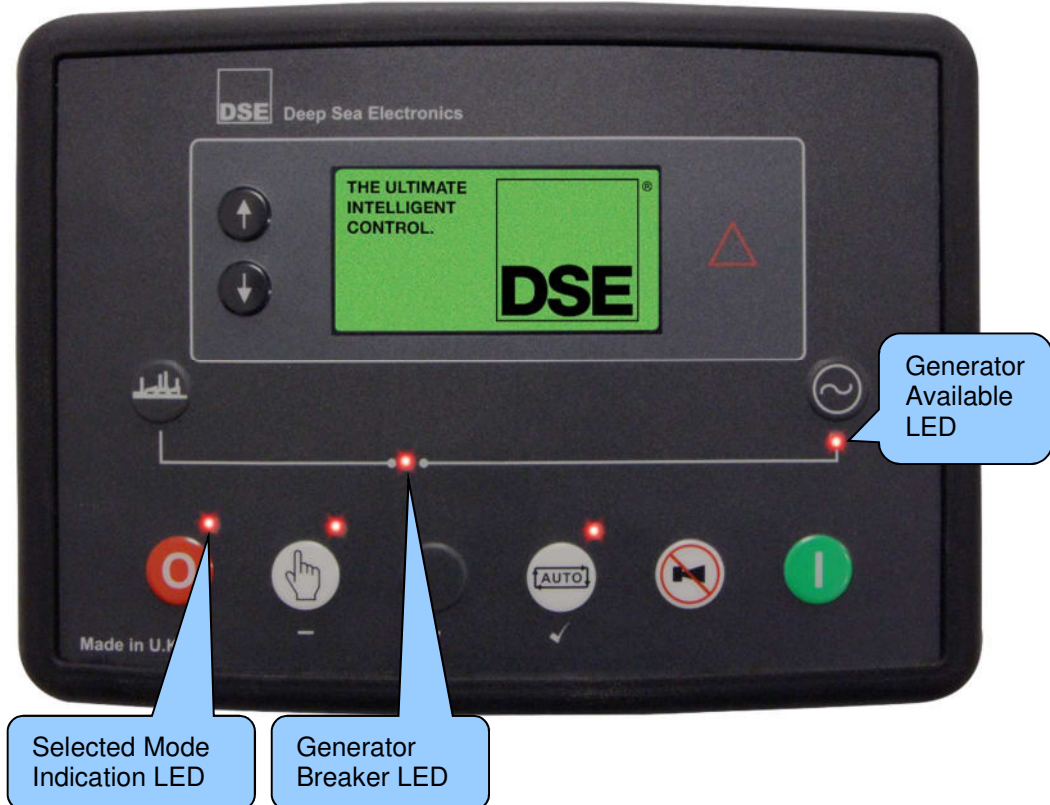
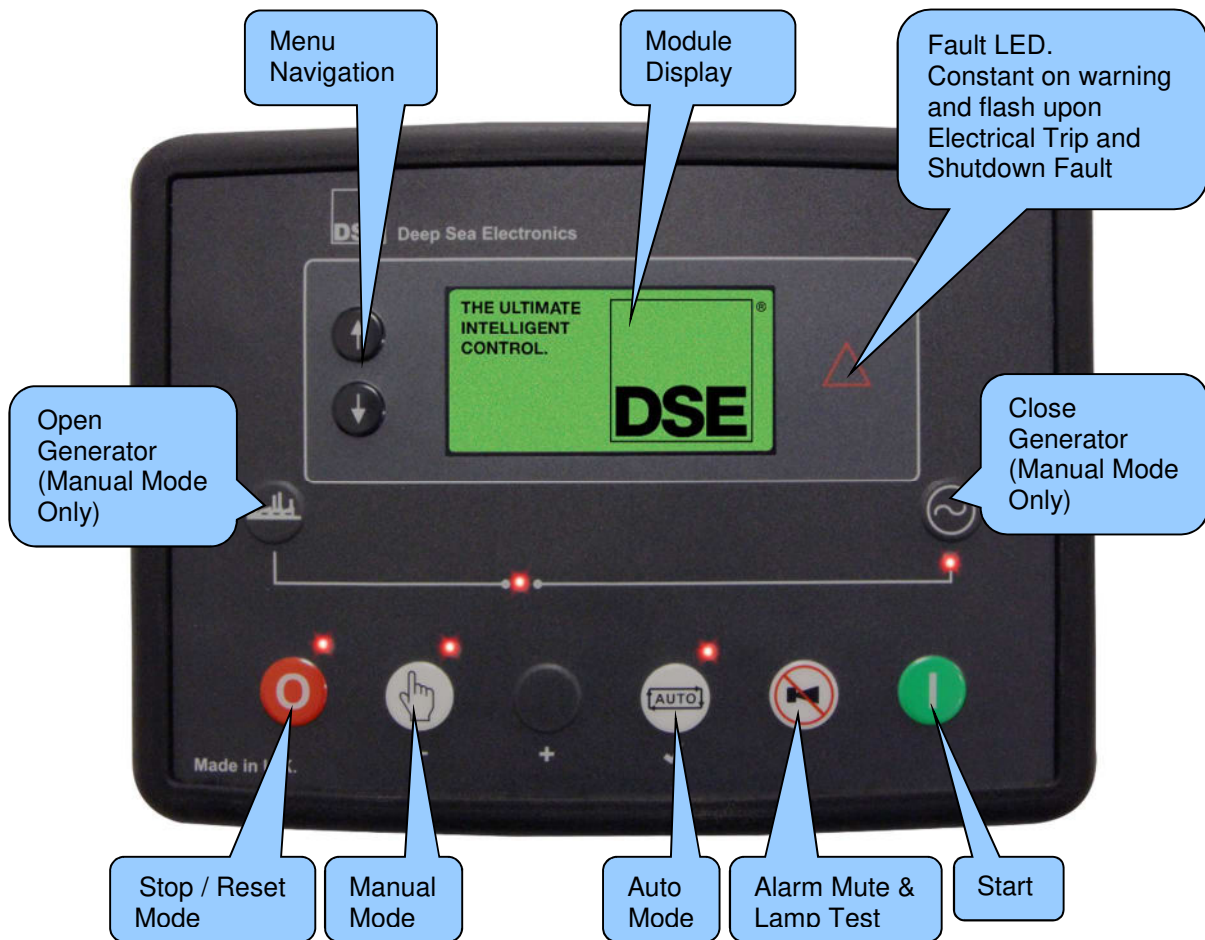



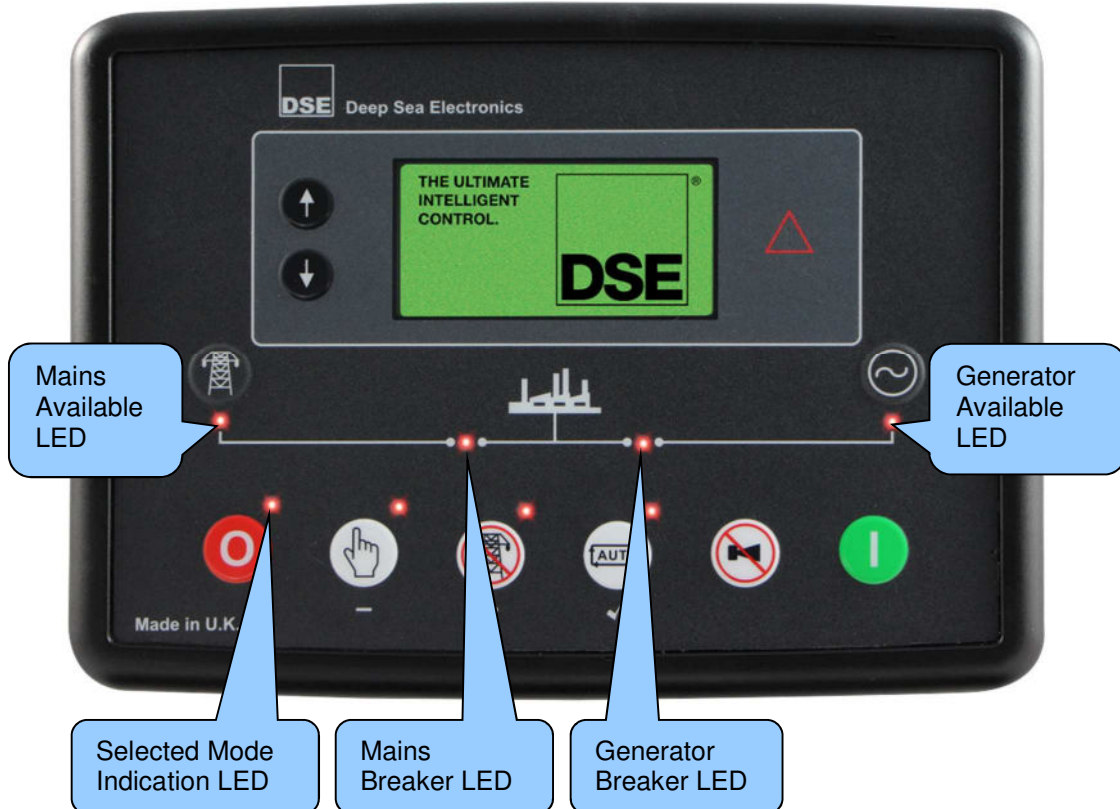
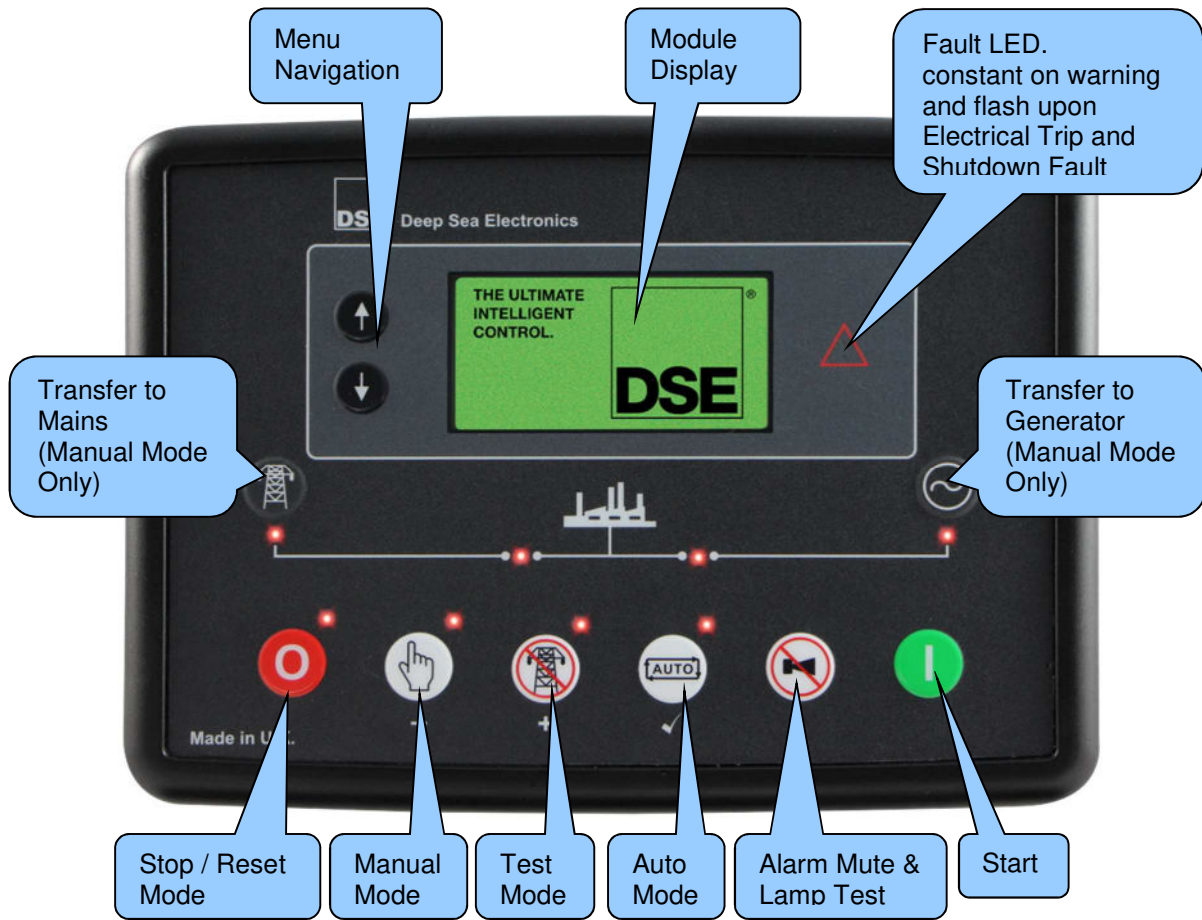

















4.2 DSE6120 MKII

















4.3 CONTROL PUSH-BUTTONS















NOTE: For further details, see section entitled *Operation* elsewhere in this manual.

Icon	Description
	<p>Stop / Reset Mode</p> <p>This button places the module into its Stop/Reset Mode . This clears any alarm conditions for which the triggering criteria has been removed. If the engine is running and the module is put into Stop/Reset Mode , the module automatically instructs the generator off load ('Close Generator Output' becomes inactive (if used on)) and place the mains on load ('Close Mains Output' becomes active (DSE6120 MKII)). The fuel supply de-energises and the engine comes to a standstill. Should any form of <i>start signal</i> be present when in Stop/Reset Mode  the generator remains at rest</p>
	<p>Manual Mode</p> <p>This button places the module into its Manual Mode . Once in Manual Mode , the module responds to the Start  button to start the generator and run it off load.</p> <p>To place the generator on load, use the Transfer to Generator  button. The module automatically instructs the changeover device to take the mains off load ('Close Mains Output' becomes inactive (if used on DSE6120 MKII)) and place the generator on load ('Close Generator Output' becomes active (if used)). To place the generator off load, use the Transfer to Mains  or Open Generator  buttons. The module automatically instructs the changeover device to take the generator off load ('Close Generator Output' becomes inactive (if used on)) and place the mains on load ('Close Mains Output' becomes active (DSE6120 MKII)). Additional digital inputs can be assigned to perform these functions.</p> <p>If the engine is running off-load in Manual Mode  and on load signal becomes active, the module automatically instructs the changeover device the changeover device to take the mains off load ('Close Mains Output' becomes inactive (if used on DSE6120 MKII)) and place the generator on load ('Close Generator Output' becomes active (if used)). Upon removal of the on load signal, the generator remains on load until either selection of the Stop/Reset Mode  or Auto Mode .</p>
	<p>Test Mode (DSE6120 MKII Only)</p> <p>This button places the module into its Test Mode . Once in Test Mode , the module responds to the Start  button to start the generator.</p> <p>Once the set has started and becomes available, it is automatically placed on load (Close Mains Output becomes inactive (if used on DSE6120 MKII) and Close Generator Output becomes active (if used)).</p> <p>The generator remains on load until either the Stop/Reset Mode  or Auto Mode  is selected.</p>

NOTE: For further details, see section entitled *Operation* elsewhere in this manual.



Icon	Description
	<p>Auto Mode</p> <p>This button places the module into its Auto Mode . This mode allows the module to control the function of the generator automatically. The module monitors numerous start requests and when one has been made, the set is automatically started. Once the generator is available, the mains is taken off load ('Close Mains Output' becomes inactive (if used on DSE6120 MKII)) and the generator is placed on load ('Close Generator Output' becomes active (if used)).</p> <p>Upon removal of the starting signal, the module starts the <i>Return Delay Timer</i> and once expired, takes the generator off load ('Close Generator Output' becomes inactive (if used on)) and place the mains on load ('Close Mains Output' becomes active (DSE6120 MKII)). The generator then continues to run for the duration of the <i>Cooling Timer</i> until it stops. The module then waits for the next start event.</p>
	<p>Alarm Mute / Lamp Test</p> <p>This button silences the audible alarm in the controller, de-activates the <i>Audible Alarm</i> output (if configured) and illuminates all of the LEDs on the module's facia as a lamp test function.</p>
	<p>Start</p> <p>This button is only active in the Stop/Reset Mode , Manual Mode  and Test Mode .</p> <p>Pressing the Start  button in Stop/Reset Mode  powers up the engine's ECU but does not start the engine. This can be used to check the status of the CAN communication and to prime the fuel system.</p> <p>Pressing the Start  button in Manual Mode  or Test Mode  starts the generator and runs it off load in Manual Mode  or on load in Test Mode .</p>
	<p>Menu Navigation</p> <p>Used for navigating the instrumentation, event log and configuration screens.</p>

NOTE: For further details, see section entitled *Operation* elsewhere in this manual.

Icon	Description
	<p>Transfer To Generator</p> <p>The Transfer to Generator  button controls the operation of the generator load switch is only active in the Manual Mode  once the generator is available.</p> <p>Pressing the Transfer to Generator  button when the Generator is available and off load, the Mains load switch is opened ('Close Mains' becomes inactive) and the Generator load switch is closed ('Close Generator' becomes active).</p> <p>Further presses of the Transfer to Generator  button have no effect.</p>
	<p>Open Generator (DSE6110 MKII Only)</p> <p>The Open Generator  button is only active in the Manual Mode  and allows the operator to open the generator load switch.</p> <p>Pressing the Open Generator  button when the Generator is on load, the generator load switch is opened ('Close Generator' becomes inactive). Further presses of the Open Generator  button have no effect.</p>
	<p>Transfer To Mains (DSE6120 MKII Only)</p> <p>The Transfer to Mains  button controls the operation of the mains load switch and is only active in Manual Mode .</p> <p>Pressing the Transfer to Mains  button when the Mains is available and off load, the generator switch is opened ('Close Generator' becomes inactive) and the mains switch is closed ('Close Mains' becomes active). Further presses of the Transfer to Mains  button have no effect.</p>

4.4 VIEWING THE INSTRUMENT PAGES

NOTE: Depending upon the module's configuration, some display screens may be disabled. For further details of module configuration, refer to DSE Publication: *057-224 DSE6110 MKII & DSE6120 MKII Configuration Software Manual*.

It is possible to scroll to display the different pages of information by pressing and holding either of the **Menu Navigation**   buttons for two seconds to move to the next or previous page.

Example

If you want to view one of the instrument pages towards the end of the list, it may be quicker to scroll down through the pages rather than right!

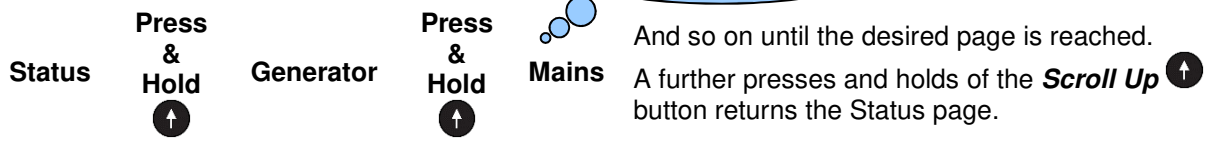

The complete order and contents of each information page are given in the following sections



Once selected, the page remains on the LCD display until the user selects a different page, or after an extended period of inactivity (*LCD Page Timer*), the module reverts to the status display.

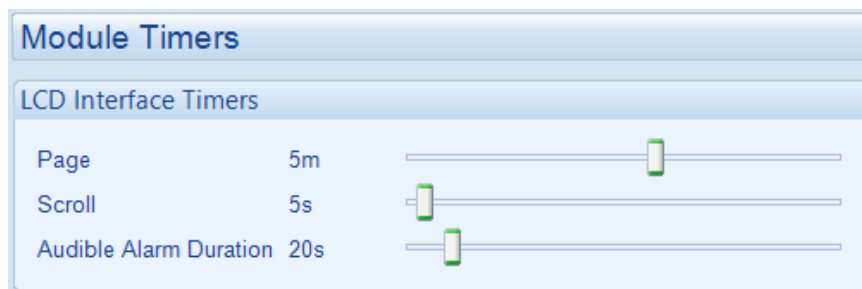

If no buttons are pressed upon entering an instrumentation page, the instruments displayed are automatically subject to the setting of the *LCD Scroll Timer*.

The *LCD Page* and *LCD Scroll* timers are configurable using the DSE Configuration Suite Software or by using the Front Panel Editor.

The screenshot below shows the factory settings for the timers, taken from the DSE Configuration Suite PC Software.



Alternatively, to scroll manually through all instruments on the currently selected page, press either of the **Menu Navigation**   buttons. The 'auto scroll' is disabled.

To re-enable 'auto scroll' press and hold either of the **Menu Navigation**   buttons to scroll to the 'title' of the instrumentation page (ie Engine). A short time later (the duration of the *LCD Scroll Timer*), the instrumentation display begins to auto scroll.

When scrolling manually, the display automatically returns to the Status page if no buttons are pressed for the duration of the configurable *LCD Page Timer*.

If an alarm becomes active while viewing the status page, the display shows the Alarms page to draw the operator's attention to the alarm condition.

4.4.1 STATUS



NOTE: Press the *Menu Navigation*   buttons on the *Status Page* to view other Configurable Status Screens if configured. For further details of module configuration, refer to DSE Publication: 057-224 *DSE6110 MKII & DSE6120 MKII Configuration Software Manual*.

This is the 'home' page, the page that is displayed when no other page has been selected, and the page that is automatically displayed after a period of inactivity (*LCD Page Timer*) of the module control buttons.

This page changes with the action of the controller for example when the generator is running and available:



Status 22:31 Generator at Rest Stop Mode	Factory setting of <i>Status</i> screen showing engine stopped...
Status 22:31 Generator Available	...and engine running

4.4.1.1 GENERATOR LOCKED OUT

Status 22:31 Generator Locked Out	<i>Generator Locked Out</i> indicates that the Generator cannot be started due to an active <i>Shutdown</i> or <i>Electrical Trip Alarm</i> on the module. Press and hold either of the <i>Menu Navigation</i>   buttons to scroll to the alarms page to investigate. Press the <i>Stop/Reset Mode</i>  button to clear the alarm, if the alarm does not clear the fault is still active.
--	--

4.4.1.2 WAITING FOR GENERATOR

NOTE: For further details of module configuration, refer to DSE Publication: 057-224 *DSE6110 MKII & DSE6120 MKII Configuration Software Manual*.

Status 22:31 Waiting For Generator	<i>Waiting For Generator</i> indicates that the Generator has started but has not reached the required <i>Loading Voltage</i> and or <i>Loading Frequency</i> as set in the module's configuration. Press and hold either of the <i>Menu Navigation</i>   buttons to scroll to the <i>Generator</i> page to check to see if the generator voltage and frequency is higher then the configured <i>Loading Voltage</i> and <i>Loading Frequency</i> .
---	--

4.4.1.3 ENHANCED TIER IV HOME SCREEN

To meet certain regulations, the home page of the controller may be changed by the generator manufacturer or supplier to display Tier IV engine information. The screenshot below shows the *Enhanced Tier IV Home Screen* enabled, taken from the DSE Configuration Suite PC Software and an example of the display.

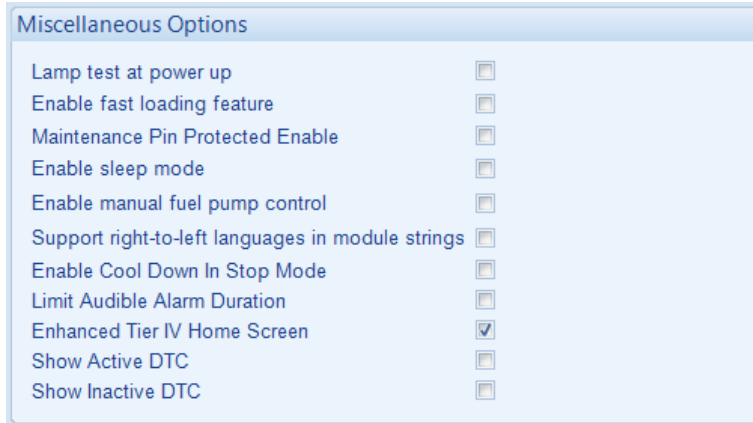

For further information about the icons, refer to *Engine* section elsewhere in this manual.

4.4.2 ENGINE

 **NOTE***: For further details of support engine, refer to DSE Publication: *057-004 Electronic Engines and DSE Wiring Guide*.

These pages contain instrumentation gathered about the engine measured or derived from the module's inputs, some of which may be obtained from the engine ECU.

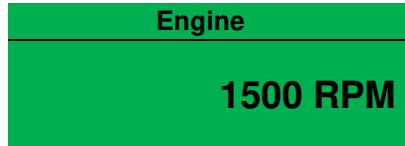









- Engine Speed
- Oil Pressure
- Coolant Temperature
- Engine Battery Volts
- Engine Run Time
- Engine Fuel Level
- Oil Temperature*
- Coolant Pressure*
- Inlet Temperature*
- Exhaust Temperature*
- Fuel Temperature*
- Turbo Pressure*
- Fuel Pressure*
- Fuel Consumption*
- Fuel Used*
- Flexible Sensors
- Engine Maintenance Alarm 1
- Engine Maintenance Alarm 2
- Engine Maintenance Alarm 3
- After Treatment Fuel Used*
- After Treatment Exhaust Gas Temperature*
- Engine Oil Level*
- Engine Crank Case Pressure*
- Engine Coolant Level*
- Engine Injector Rail Pressure*
- Engine Exhaust Temperature*
- Intercooler Temperature*
- Turbo Oil Pressure*
- Fan Speed*
- Water In Fuel*
- Air Inlet Pressure*
- ECU Regeneration*
- ECU Regeneration Icons*
- Engine Soot Levels*
- DEF Tank Level*
- DEF Tank Temperature*
- DEF Reagent Cons*
- SCR After Treatment Status*
- ECU ECR DEF Icons*
- DEF Counter Minimum*
- DPTC Filter Status*
- Engine ECU Link*
- Tier 4 Engine Information*

4.4.2.1 DPF REGENERATION LAMPS

NOTE: For further details of module configuration, refer to DSE Publication: *057-224 DSE6110 MKII & DSE6120 MKII Configuration Software Manual.*

Depending upon the *Engine Type* selected in the module's configuration, the *Engine* section may include the *DPF Regeneration Lamps* page. This page contains icons to show the status of various ECU functions, some of which are applicable to Tier 4 engine requirements. The icons flash at different rates to show the status of the ECU function, refer to the engine manufacturer for more information about this.

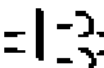
Icon	Fault	Description
	ECU Amber Alarm	The module received an Amber fault condition from the engine ECU.
	ECU Red Alarm	The module received a Red fault condition from the engine ECU.
	DPF Active	The module received a fault indication from the engine ECU informing that the <i>Diesel Particulate Filter</i> is active.
	DPF Inhibited	The module received a fault indication from the engine ECU informing that the <i>Diesel Particulate Filter</i> has been inhibited.
	DPF Stop	The module received a fault indication from the engine ECU informing that the <i>Diesel Particulate Filter</i> has been stopped.
	DPF Warning	The module received a fault condition from the engine ECU informing that the <i>Diesel Particulate Filter</i> has a fault condition.
	HEST Active	The module received a fault indication from the engine ECU informing that the <i>High Exhaust System Temperature</i> is active.
	DEF Low Level	The module received a fault condition from the engine ECU informing that the <i>Diesel Exhaust Fluid Low Level</i> is active.
	SCR Inducement	The module received a fault indication from the engine ECU informing that the <i>Selective Catalytic Reduction Inducement</i> is active.

Example:

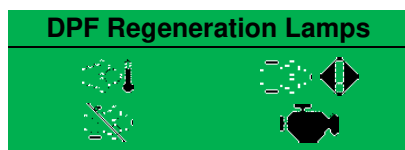

4.4.3 GENERATOR

Contains electrical values of the generator, measured or derived from the module's voltage and current inputs.

Press either of the **Menu Navigation**   buttons to scroll through the **Generator** parameters.

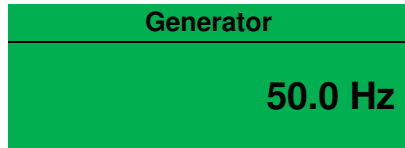

- Generator Voltage (ph-N)
- Generator Voltage (ph-ph)
- Generator Frequency
- Generator Current (A)
- Generator Load ph-N (kW)
- Generator Total Load (kW)
- Generator Load ph-N (kVA)
- Generator Total Load (kVA)
- Generator Power Factor Average
- Generator Load ph-N (kvar)
- Generator Total Load (kvar)
- Generator Accumulated Load (kWh, kVAh, kvarh)
- Generator Phase Sequence
- Active Configuration

4.4.4 MAINS (DSE6120 MKII ONLY)

NOTE*: Mains current and powering monitoring is only available when the CTs are configured for, and placed in the load. For further details of module configuration, refer to DSE Publication: 057-224 DSE6110 MKII & DSE6120 MKII Configuration Software Manual.

Contains electrical values of the mains (utility), measured or derived from the module's voltage and current inputs.

Press either of the **Menu Navigation**   buttons to scroll through the **Mains** parameters.

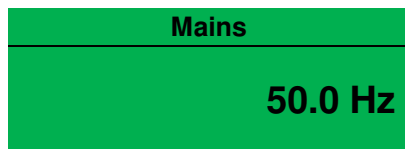

- Mains Voltage (ph-N)
- Mains Voltage (ph-ph)
- Mains Frequency
- Mains Current (A)*
- Mains Phase Sequence
- Mains Load ph-N (kW)*
- Mains Total Load (kW)*
- Mains Load ph-N (kVA)*
- Mains Total Load (kVA)*
- Mains Single Phase Power Factor*
- Mains Average Power Factor*
- Mains Load ph-N (kvar)*
- Mains Total Load (kvar)*
- Mains Accumulated Load (kWh, kVAh, kvarh)*

4.4.5 EXPANSION

NOTE: Depending upon the module's configuration, some display screens may be disabled. For further details of module configuration, refer to DSE Publication: *057-224 DSE6110 MKII & DSE6120 MKII Configuration Software Manual*.

Contains measured values from various input expansion modules that are connected to the DSE module.

Press either of the **Menu Navigation**   buttons to scroll through the **Expansion** parameters.

Oil Temperature
80 °C
176 °F

- DSE2130 ID0 Analogue Input E
- DSE2130 ID0 Analogue Input F
- DSE2130 ID0 Analogue Input G
- DSE2130 ID0 Analogue Input H
- DSE2130 ID1 Analogue Input E
- DSE2130 ID1 Analogue Input F
- DSE2130 ID1 Analogue Input G
- DSE2130 ID1 Analogue Input H

4.4.6 ALARMS

When an alarm is active, the *Internal Audible Alarm* sounds and the Common Alarm LED, if configured, illuminates.

The audible alarm is silenced by pressing the **Alarm Mute / Lamp Test**  button.

The LCD display jumps from the 'Information page' to display the Alarm Page

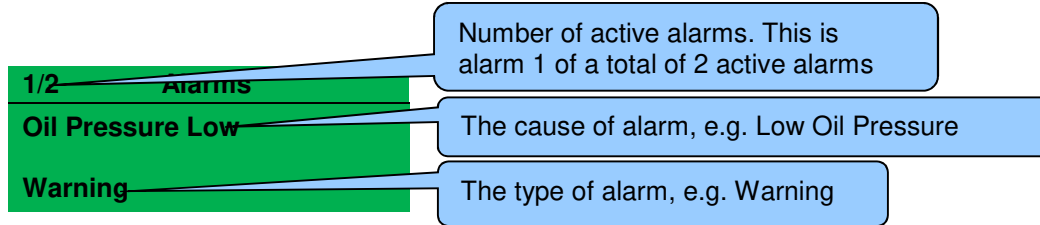

The LCD displays multiple alarms such as "*Coolant Temperature High*", "*Emergency Stop*" and "*Low Coolant Warning*". These automatically scroll in the order that they occurred or press either of the

Menu Navigation   buttons to scroll through manually.

In the event of an alarm, the LCD displays the appropriate text. If an additional alarm then occurs, the module displays the appropriate text.

Example:

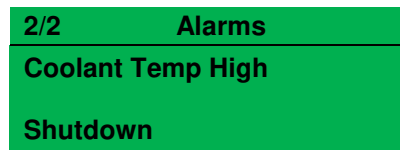
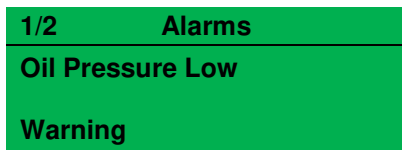

4.4.6.1 ECU ALARMS (CAN ERROR MESSAGE / DTC)

NOTE: For details on these code meanings, refer to the ECU instructions provided by the engine manufacturer, or contact the engine manufacturer for further assistance.

NOTE: For further details on connection to electronic engines, refer to DSE Publication: *057-004 Electronic Engines And DSE Wiring*

When connected to a suitable CAN engine, the controller displays alarm status messages from the ECU in the *Alarms* section of the display.

1/1	Alarms
ECU Warning	
Warning	

Type of alarm that is triggered on the DSE module, e.g. Warning

Press and hold the **Scroll Down** button to access the list of *ECU Current DTCs* (Diagnostic Trouble Codes) from the ECU which are DM1 messages.

1/2	ECU Current DTCs	The DM1 DTC is interpreted by the module and is shown on the module's display as a text message. In addition to this, the manufacturer's DTC is shown below.
Water Level Low		
SPN=131166, FMI=8, OC=127		

Press and hold the **Scroll Down** button to access the list of *ECU Prev. DTCs* (Diagnostic Trouble Codes) from the ECU which are DM2 messages.

1/10	ECU Prev. DTCs	The DM2 DTC is interpreted by the module and is shown on the module's display as a text message. In addition to this, the manufacturer's DTC is shown below.
Water Level Low		
SPN=131166, FMI=8, OC=127		

4.4.7 EVENT LOG

NOTE: For further details of module configuration, refer to DSE Publication: *057-224 DSE6110 MKII & DSE6120 MKII Configuration Software Manual.*

The module maintains a log of past alarms and/or selected status changes. The log size has been increased in the module over past module updates and is always subject to change. At the time of writing, the modules log is capable of storing the last 50 log entries.

Under default factory settings, the event log is configured to include all possible options; however, this is configurable by the system designer using the DSE Configuration Suite software.

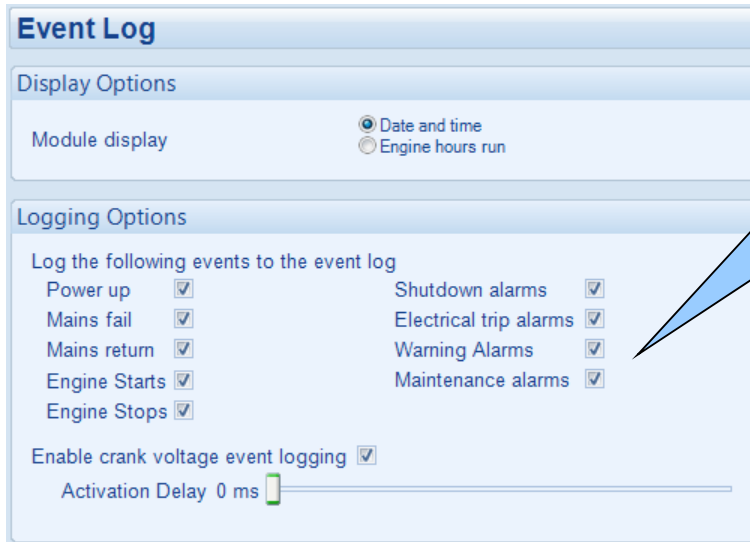



Example showing the possible configuration of the event log (DSE Configuration Suite Software).

This also shows the factory settings of the module.

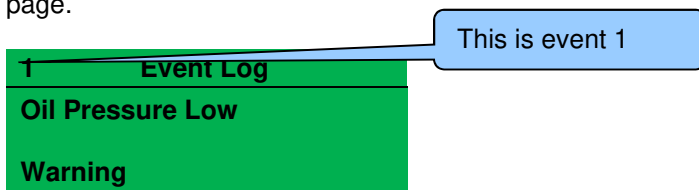

When the event log is full, any subsequent event overwrites the oldest entry. Hence, the event log always contains the most recent events. The module logs the event type, along with the date and time (or engine running hours if configured to do so).

To view the event log, press either of the **Menu Navigation**   buttons to scroll to *the Event Log* page.



Press the **Scroll Down**  button to view the next most recent event.

Continuing to press the **Scroll Down**  button cycles through the past events after which, the display shows the most recent alarm and the cycle begins again.

To exit the event log and return to viewing the instruments, press and hold either of the **Menu Navigation**   buttons to select the next instrumentation page.

4.4.8 LCD INDICATORS

NOTE: For further details of module configuration, refer to DSE Publication: *057-224 DSE6110 MKII & DSE6120 MKII Configuration Software Manual.*

These LCD Indicators are configured by the user to indicate any one of **100+ different functions** based around the following:-

- **Indications** - Monitoring of a digital input and indicating associated functioning user’s equipment - *Such as Battery Charger On or Louvres Open, etc.*
- **Warnings, Electrical Trip & Shutdowns Alarms** - Specific indication of a particular warning or shutdown condition, backed up by LCD indication - *Such as Low Oil Pressure Shutdown, Low Coolant level, etc.*
- **Status Indications** - Indication of specific functions or sequences derived from the modules operating state - *Such as Safety On, Pre-heating, Panel Locked, etc.*

The display below example screen is achieved using the settings shown in the below screen shot of the DSE Configuration Suite Software:

LCD Indicators		
<input type="radio"/>	Remote Start Active	
<input type="radio"/>	Auto Start Inhibit	
<input type="radio"/>	Louvre Open	

LCD Indicators			LCD Description
1	Remote Start On Load	Lit	Remote Start Active
2	Auto Start Inhibit	Lit	Auto Start Inhibit
3	Louvre Control	Unlit	Louvre Open

4.4.9 USER DEFINED STRINGS

NOTE: Depending upon the module’s configuration, some display screens may be disabled. For further details of module configuration, refer to DSE Publication: *057-224 DSE6110 MKII & DSE6120 MKII Configuration Software Manual.*

The user define strings are intended to contain generic important information about the generator such as oil service internal information. The contents of these screens vary depending upon configuration by the engine manufacturer or supplier.

Under default factory settings the support strings are not viewable. They are configurable by the system designer using the DSE Configuration Suite software.

The display below example screen is achieved using the settings shown in the below screen shot of the DSE Configuration Suite Software:

Oil Service	
Every 500 Hours	
Every 5 Months	

User Defined Strings	
Page 1	
Line 1	Oil Service
Line 2	Every 500 Hours
Line 3	Every 5 Months

4.4.10 CONFIGURABLE CAN

NOTE: Depending upon the module's configuration, some display screens may be disabled. For further details of module configuration, refer to DSE Publication: *057-224 DSE6110 MKII & DSE6120 MKII Configuration Software Manual*.

The configurable CAN instruments are intended to display CAN information from external third party CAN devices such as fuel flow meters. The contents of these screens vary depending upon configuration by the engine manufacturer or supplier.

Under default factory settings the configurable CAN instruments are not viewable. They are configurable by the system designer using the DSE Configuration Suite software.

Example:

Fuel Flow
84 L/h

- Configurable CAN Instrument 1
- Configurable CAN Instrument 2
- Configurable CAN Instrument 3
- Configurable CAN Instrument 4
- Configurable CAN Instrument 5
- Configurable CAN Instrument 6
- Configurable CAN Instrument 7
- Configurable CAN Instrument 8
- Configurable CAN Instrument 9
- Configurable CAN Instrument 10
- Configurable CAN Instrument 11
- Configurable CAN Instrument 12
- Configurable CAN Instrument 13
- Configurable CAN Instrument 14
- Configurable CAN Instrument 15
- Configurable CAN Instrument 16
- Configurable CAN Instrument 17
- Configurable CAN Instrument 18
- Configurable CAN Instrument 19
- Configurable CAN Instrument 20
- Configurable CAN Instrument 21
- Configurable CAN Instrument 22
- Configurable CAN Instrument 23
- Configurable CAN Instrument 24
- Configurable CAN Instrument 25
- Configurable CAN Instrument 26
- Configurable CAN Instrument 27
- Configurable CAN Instrument 28
- Configurable CAN Instrument 29
- Configurable CAN Instrument 30

4.4.11 ABOUT

4.4.11.1 MODULE INFORMATION

Contains important information about the module and the firmware versions. This information may be asked for when contacting DSE Technical Support Department for advice.

About	
Variant	6120H
Application	V1.1.5
USB ID	BC614E

Variant: 61xx MKII
Application Version: The version of the module's main firmware file (Updatable using the Firmware Update Wizard in the DSE Configuration Suite Software).
USB ID: Unique identifier for PC USB connection

Press the **Scroll Down**  button to access more information about the module.

About	
Bootloader	V1.4.0
Analogue	V2.0.1

Bootloader: Firmware Update bootloader software version
Analogue: Analogue measurements software version

About	
Engine Type	Volvo EMS2b
Version	V1.21

Engine Type: The name of the engine file selected in the configuration
Version: Engine type file version.

4.4.11.2 SUPPORT STRINGS

 **NOTE:** Depending upon the module's configuration, some display screens may be disabled. For further details of module configuration, refer to DSE Publication: *057-224 DSE6110 MKII & DSE6120 MKII Configuration Software Manual*.

The support string pages are intended to contain important information about the generator supplier company such as contact information. The contents of these screens vary depending upon configuration by the engine manufacturer or supplier.

Under default factory settings the support strings are not viewable. They are configurable by the system designer using the DSE Configuration Suite software.

The display below example screen is achieved using the settings shown in the below screen shot of the DSE Configuration Suite Software:

Support
Deep Sea Electronics +44 (0)1723 890099 support@deepseapl.com

Support Strings

Page 1

Line 1 Deep Sea Electronics
 Line 2 +44 (0)1723 890099
 Line 3 support@deepseapl.com

5 OPERATION

NOTE: The following descriptions detail the sequences followed by a module containing the standard 'factory configuration'. Always refer to your configuration source for the exact sequences and timers observed by any particular module in the field.

5.1 QUICKSTART GUIDE

This section provides a quick start guide to the module's operation.

5.1.1 STARTING THE ENGINE

NOTE: For further details, see the section entitled 'OPERATION' elsewhere in this manual.



5.1.2 STOPPING THE ENGINE

NOTE: For further details, see the section entitled 'OPERATION' elsewhere in this manual.





5.2 STOP/RESET MODE

 **NOTE:** If a digital input configured to *Panel Lock* is active, changing module modes is not possible. Viewing the instruments and event logs is **NOT** affected by *Panel Lock*.

 **NOTE:** For further details of module configuration, refer to DSE Publication: *057-224 DSE6110 MKII & DSE6120 MKII Configuration Software Manual*.

Stop/Reset Mode is activated by pressing the *Stop/Reset Mode*  button.

The LED above the *Stop/Reset Mode*  button illuminates to indicate *Stop/Reset Mode*  operation.

In *Stop/Reset Mode* , the module removes the generator from load (if necessary) before stopping the generator.

If the generator does not stop when requested, the *Fail To Stop* alarm is activated (subject to the setting of the *Fail to Stop* timer). To detect the engine at rest the following must occur:

- Engine speed is zero as detected by the CAN ECU
- Generator AC Voltage and Frequency must be zero.
- Engine Charge Alternator Voltage must be zero.
- Oil pressure sensor must indicate low oil pressure

When the engine has stopped and the module is in the *Stop/Reset Mode* , it is possible to send configuration files to the module from DSE Configuration Suite PC software and to enter the Front Panel Editor to change parameters.

Any latched alarms that have been cleared are reset when *Stop/Reset Mode*  is entered.

The engine is not started when in *Stop/Reset Mode* . If start signals are given, the input is ignored until *Auto Mode*  is entered.

If *Immediate Mains Dropout* is enabled and the module is in *Stop/Reset Mode* , the mains load switch is opened and closed as appropriate when the mains fails or becomes available to take load.



When left in *Stop/Reset Mode*  with no presses of the fascia buttons, no form of communication active and configured for *Power Save Mode*, the module enters *Power Save Mode*. To 'wake' the module, press any fascia control buttons.

Power Save Mode in the DSE Configuration Suite Software

Power Save Mode Enable





5.2.1 ECU OVERRIDE

Pressing the *Start*  button in *Stop/Reset Mode*  powers up the engine's ECU but does not start the engine. This can be used to check the status of the CAN communication and to prime the fuel system.

5.3 MANUAL MODE

NOTE: If a digital input configured to Panel Lock is active, changing module modes is not possible. Viewing the instruments and event logs is NOT affected by panel lock.

Manual Mode is activated by pressing the **Manual Mode**  button.

The LED above the **Manual Mode**  button illuminates to indicate **Manual Mode**  operations.

In **Manual Mode**  the generator does not start automatically

To begin the starting sequence, press the **Start**  button.

5.3.1 STARTING SEQUENCE

NOTE: There is no **Start Delay** in this mode of operation.

NOTE: If the unit has been configured for CAN, compatible ECU's receives the start command via CAN.

NOTE: For further details of module configuration, refer to DSE Publication: *057-224 DSE6110 MKII & DSE6120 MKII Configuration Software Manual*.

The fuel relay is energised and the engine is cranked.

If the engine fails to fire during this cranking attempt then the starter motor is disengaged for the *Crank Rest Timer* duration after which the next start attempt is made. Should this sequence continue beyond the set *Number Of Attempts*, the start sequence is terminated and the display shows *Fail to Start*.

The starter motor is disengaged when the engine fires. Speed detection is factory configured to be derived from the AC alternator output frequency, but can additionally be measured from a Magnetic Pickup mounted on the flywheel or from the CANbus link to the engine ECU depending on module configuration.

Additionally, rising oil pressure can be used to disconnect the starter motor (but cannot detect underspeed or overspeed).

After the starter motor has disengaged, the *Safety On Delay* timer activates, allowing Oil Pressure, High Engine Temperature, Under-speed, Charge Fail and any delayed Auxiliary fault inputs to stabilise without triggering the fault.



5.3.2 ENGINE RUNNING



NOTE: The load transfer signal remains inactive until the generator is available. This prevents excessive wear on the engine and alternator.

In **Manual Mode** , the load is not transferred to the generator unless a 'loading request' is made. A loading request can come from a number of sources.

- Press the Transfer to Generator  button
- Failure of mains supply (DSE6120 MKII only)
- Activation of an auxiliary input that has been configured to *Remote Start On Load or Auxiliary Mains Fail* (DSE6120 MKII Only).
- Activation of the inbuilt exercise scheduler if configured for 'on load' runs.



Once the generator has been placed on load, it is not automatically removed. To manually remove the load either:

Press the **Open Generator**  (DSE6110 MKII Only) or **Transfer to Mains**  (DSE6120 MKII Only) button

- Press the **Auto Mode**  button to return to automatic mode. The set observes all **Auto Mode**  start requests and stopping timers before beginning the *Auto Mode Stopping Sequence*.
- Press the **Stop/Reset Mode**  button to remove load and stop the generator.
- Activation of an auxiliary input that has been configured to *Generator Load Inhibit*.

5.3.3 STOPPING SEQUENCE

In **Manual Mode**  the set does not continue to run until either:

- The **Stop/Reset Mode**  button is pressed
- The **Auto Mode**  button is pressed. The set observes all **Auto Mode**  start requests and stopping timers before beginning the *Auto Mode Stopping Sequence*.

5.4 TEST MODE

 **NOTE:** If a digital input configured to *Panel Lock* is active, changing module modes is not possible. Viewing the instruments and event logs is **NOT** affected by *Panel Lock*.

Test Mode is activated by pressing the *Test Mode*  button.

The LED above the *Test Mode*  button illuminates to indicate *Test Mode*  operations.

In *Test Mode* , the set does not start automatically.

To begin the starting sequence, press the *Start*  button.

5.4.1 STARTING SEQUENCE

 **NOTE:** There is no *Start Delay* in this mode of operation.

 **NOTE:** If the unit has been configured for CAN, compatible ECU's receives the start command via CAN.

 **NOTE:** For further details of module configuration, refer to DSE Publication: *057-224 DSE6110 MKII & DSE6120 MKII Configuration Software Manual*.

The fuel relay is energised and the engine is cranked.

If the engine fails to fire during this cranking attempt then the starter motor is disengaged for the *crank rest* duration after which the next start attempt is made. Should this sequence continue beyond the set number of attempts, the start sequence is terminated and the display shows *Fail to Start*.

The starter motor is disengaged when the engine fires. Speed detection is factory configured to be derived from the AC alternator output frequency, but can additionally be measured from a Magnetic Pickup mounted on the flywheel or from the CANbus link to the engine ECU depending on module configuration.

Additionally, rising oil pressure can be used to disconnect the starter motor (but cannot detect underspeed or overspeed).



After the starter motor has disengaged, the *Safety On Delay* timer activates, allowing Oil Pressure, High Engine Temperature, Under-speed, Charge Fail and any delayed Auxiliary fault inputs to stabilise without triggering the fault.



5.4.2 ENGINE RUNNING

NOTE: The load transfer signal remains inactive until the generator is available. This prevents excessive wear on the engine and alternator.

In **Test Mode** , the load is automatically transferred to the generator.



Once the generator has been placed on load, it is not automatically removed. To manually remove the load either:

Press the **Manual Mode**  button followed by the **Open Generator**  (DSE6110 MKII Only) or **Transfer to Mains**  (DSE6120 MKII Only) button.

- Press the **Auto Mode**  button to return to automatic mode. The set observes all **Auto Mode**  start requests and stopping timers before beginning the *Auto Mode Stopping Sequence*.
- Press the **Stop/Reset Mode**  button to remove load and stop the generator.
- Activation of an auxiliary input that has been configured to *Generator Load Inhibit*.

5.4.3 STOPPING SEQUENCE



In **Test Mode**  the set continues to run until either:

- The **Stop/Reset Mode**  button is pressed
- The **Auto Mode**  button is pressed. The set observes all **Auto Mode**  start requests and stopping timers before beginning the *Auto Mode Stopping Sequence*.

5.5 AUTOMATIC MODE

 **NOTE:** If a digital input configured to external *Panel Lock* is active, changing module modes is not possible. Viewing the instruments and event logs is NOT affected by *Panel Lock*.

Auto Mode is activated by pressing the **Auto Mode**  button.

The LED above the **Auto Mode**  button illuminates to indicate **Auto Mode**  operations.

Auto Mode  allows the generator to operate fully automatically, starting and stopping as required with no user intervention.

5.5.1 WAITING IN AUTO MODE

If a starting request is made, the starting sequence begins. Starting requests can be from the following sources:

- Failure of mains supply (DSE6120 MKII only)
- Activation of an auxiliary input that has been configured to *Remote Start*
- Activation of an auxiliary input that has been configured to *Auxiliary Mains Fail* (DSE6120 MKII Only).
- Activation of the inbuilt exercise scheduler.

5.5.2 STARTING SEQUENCE

 **NOTE:** If the unit has been configured for CAN, compatible ECU's receive the start command via CAN and transmit the engine speed to the DSE controller.

 **NOTE:** For further details of module configuration, refer to DSE Publication: *057-224 DSE6110 MKII & DSE6120 MKII Configuration Software Manual*.

To allow for 'false' start requests, the *Start Delay* timer begins.

Should all start requests be removed during the *Start Delay* timer, the unit returns to a stand-by state.

If a start request is still present at the end of the *Start Delay* timer, the fuel relay is energised and the engine is cranked.

If the engine fails to fire during this cranking attempt then the starter motor is disengaged for the *Crank Rest* duration after which the next start attempt is made. Should this sequence continue beyond the *Set Number Of Attempts*, the start sequence is terminated and the display shows *Fail to Start*.

The starter motor is disengaged when the engine fires. Speed detection is factory configured to be derived from the AC alternator output frequency, but can additionally be measured from a Magnetic Pickup mounted on the flywheel or from the CAN link to the engine ECU depending on module.

Additionally, rising oil pressure can be used to disconnect the starter motor (but cannot detect underspeed or overspeed).

After the starter motor has disengaged, the *Safety On Delay* timer activates, allowing Oil Pressure, High Engine Temperature, Under-speed, Charge Fail and any delayed Auxiliary fault inputs to stabilise without triggering the fault.

5.5.3 ENGINE RUNNING

 **NOTE: The load transfer signal remains inactive until the generator is available. This prevents excessive wear on the engine and alternator.**

The generator is placed on load if configured to do so.

If all start requests are removed, the *Stopping Sequence* begins.

5.5.4 STOPPING SEQUENCE

The *Return Delay* timer operates to ensure that the starting request has been permanently removed and isn't just a short term removal. Should another start request be made during the cooling down period, the set returns on load.

If there are no starting requests at the end of the *Return Delay* timer, the load is transferred from the generator to the mains supply and the *Cooling Down* timer is initiated.

The *Cooling Down* timer allows the set to run off load and cool sufficiently before being stopped. This is particularly important where turbo chargers are fitted to the engine.

After the *Cooling Down* timer has expired, the set is stopped.

5.6 SCHEDULER

The controller contains an inbuilt exercise run scheduler, capable of automatically starting and stopping the set or inhibiting the set from starting. Up to 8 scheduled start/stop/inhibiting start sequences can be configured to repeat on a 7-day or 28-day cycle.

Scheduled runs may be on load or off load depending upon module configuration.

Example:

Screen capture from DSE Configuration Suite Software showing the configuration of the Exercise Scheduler.



In this example the set starts at 09:00 on Monday and run for 5 hours off load, then start at 13:30 on Tuesday and run for 30 minutes one load and is inhibited from automatically starting on Monday from 17:00 for 12 hours.

Week	Day	Run Mode	Start Time	Duration	
First	Monday	Off Load	09:00	05:00	Clear
First	Tuesday	Off Load	13:30	00:30	Clear
First	Monday	Auto Start Inhibit	17:30	12:00	Clear
First	Monday	Off Load	00:00	00:00	Clear
First	Monday	Off Load	00:00	00:00	Clear
First	Monday	Off Load	00:00	00:00	Clear
First	Monday	Off Load	00:00	00:00	Clear
First	Monday	Off Load	00:00	00:00	Clear

5.6.1 STOP MODE

- Scheduled runs do not occur when the module is in **Stop/Reset Mode** .





5.6.2 MANUAL MODE

- Scheduled runs do not occur when the module is in **Manual Mode**  waiting for a start request.
- Activation of a Scheduled Run 'On Load' when the module is operating Off Load in **Manual Mode**  forces the set to run On Load.

5.6.3 TEST MODE

- Scheduled runs do not occur when the module is in **Test Mode**  waiting for a start request.

5.6.4 AUTO MODE

- Scheduled runs operate only if the module is in **Auto Mode**  with no *Shutdown* or *Electrical Trip* alarm active.
- If the module is in **Stop/Reset Mode**  or **Manual Mode**  when a scheduled run begins, the engine is not started. However, if the module is moved into **Auto Mode**  during a scheduled run, the engine is called to start.
- Depending upon configuration by the system designer, an external input can be used to inhibit a scheduled run.
- If the engine is running *Off Load* in **Auto Mode**  and a scheduled run configured to 'On Load' begins, the set is placed *On Load* for the duration of the Schedule.

6 PROTECTIONS

6.1 ALARMS

When an alarm is active, the *Internal Audible Alarm* sounds and the Common Alarm LED, if configured, illuminates.

The audible alarm is silenced by pressing the **Alarm Mute / Lamp Test**  button.

The LCD display jumps from the 'Information page' to display the Alarm Page

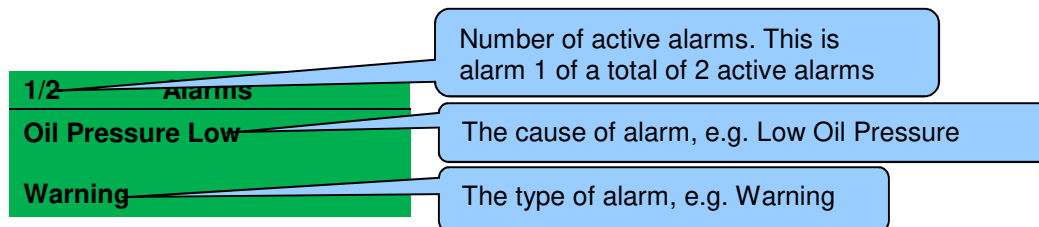

The LCD displays multiple alarms such as "*Coolant Temperature High*", "*Emergency Stop*" and "*Low Coolant Warning*". These automatically scroll in the order that they occurred or press either of the

Menu Navigation   buttons to scroll through manually.

In the event of an alarm, the LCD displays the appropriate text. If an additional alarm then occurs, the module displays the appropriate text.

Example:

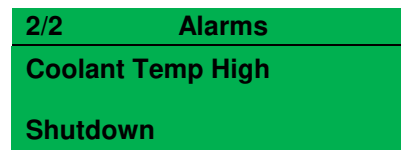
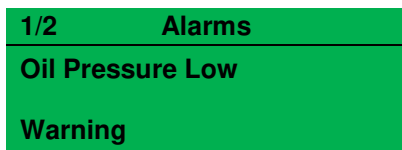

6.1.1 ECU ALARMS (CAN ERROR MESSAGE / DTC)

NOTE: For details on these code meanings, refer to the ECU instructions provided by the engine manufacturer, or contact the engine manufacturer for further assistance.

NOTE: For further details on connection to electronic engines, refer to DSE Publication: *057-004 Electronic Engines And DSE Wiring*

When connected to a suitable CAN engine, the controller displays alarm status messages from the ECU in the *Alarms* section of the display.

1/1	Alarms
ECU Warning	
Warning	

Type of alarm that is triggered on the DSE module, e.g. Warning

Press and hold the **Scroll Down** button to access the list of *ECU Current DTCs* (Diagnostic Trouble Codes) from the ECU which are DM1 messages.

1/2	ECU Current DTCs
Water Level Low	
SPN=131166, FMI=8, OC=127	

The DM1 DTC is interpreted by the module and is shown on the module's display as a text message. In addition to this, the manufacturer's DTC is shown below.

Press and hold the **Scroll Down** button to access the list of *ECU Prev. DTCs* (Diagnostic Trouble Codes) from the ECU which are DM2 messages.

1/10	ECU Prev. DTCs
Water Level Low	
SPN=131166, FMI=8, OC=127	

The DM2 DTC is interpreted by the module and is shown on the module's display as a text message. In addition to this, the manufacturer's DTC is shown below.

6.2 INDICATIONS

Indications are non-critical and often status conditions. They do not appear on the LCD display of the module as a text message in the *Status*, *Event Log* or *Alarms* pages. However, an output or LCD indicator is configured to draw the operator's attention to the event.

Example

- Input configured for indication.
- The LCD text does not appear on the module display but can be added in the configuration to remind the system designer what the input is used for.
- As the input is configured to *Indication* there is no alarm generated.
- LCD Indicator 1 'illuminates' when Digital Input A is active.
- The LCD Description allows the system designer to detail the LCD Indicator function.

Digital Input A

Function: User Configured

Polarity: Open to Activate

Action: Indication

Arming: Always

LCD Display: Panel Door Open

Activation Delay: 0s

LCD Indicators

		Lit	LCD Description
1	Digital Input A	Lit	Panel Door Open
2	Common Warning	Lit	LCD Indicator 2
3	Common Shutdown	Lit	LCD Indicator 3

Example

The LCD Indicators on the module display show the status of the configured indicator.

LCD Indicators	
○	Panel Door Open
○	LCD Indicator 2
○	LCD Indicator 3

6.3 WARNING ALARMS

Warnings are non-critical alarm conditions and do not affect the operation of the engine system, they serve to draw the operators attention to an undesirable condition.

Example:

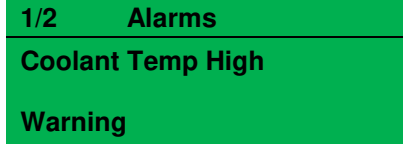

In the event of an alarm the LCD jumps to the alarms page, and scroll through all active alarms.

By default, warning alarms are self-resetting when the fault condition is removed. However enabling *All Warnings Are Latched* causes warning alarms to latch until reset manually. This is enabled using the DSE Configuration Suite in conjunction with a compatible PC.

If the module is configured for **CAN** and receives an “error” message from the ECU, ‘ECU Warning’ is shown on the module’s display as a warning alarm.

Fault	Description
2130 ID 0 to 1 Analogue Input E to H High	<p>▲ NOTE: Due to module configuration the alarm message that appears on the display may be different. For further details of module configuration, refer to DSE Publication: 057-224 DSE6110 MKII & DSE6120 MKII Configuration Software Manual.</p> <p>The module detected that an analogue input value of a DSE2130 had risen above the <i>Flexible Sensor High Pre-Alarm Trip</i> level.</p>
2130 ID 0 to 1 Analogue Input E to H Low	<p>▲ NOTE: Due to module configuration the alarm message that appears on the display may be different. For further details of module configuration, refer to DSE Publication: 057-224 DSE6110 MKII & DSE6120 MKII Configuration Software Manual.</p> <p>The module detected that an analogue input value of a DSE2130 had fallen below the <i>Flexible Sensor Low Pre-Alarm Trip</i> level.</p>
2130 ID 0 to13 Digital Input A to H	<p>▲ NOTE: Due to module configuration the alarm message that appears on the display may be different. For further details of module configuration, refer to DSE Publication: 057-224 DSE6110 MKII & DSE6120 MKII Configuration Software Manual.</p> <p>The module detected that a digital input configured to create a fault condition on a DSE2130 expansion module became active and the appropriate LCD message displayed.</p>

Continued over page...

Fault	Description
Analogue Input A to D (Digital)	<p>▲ NOTE: Due to module configuration the alarm message that appears on the display may be different. For further details of module configuration, refer to DSE Publication: 057-224 DSE6110 MKII & DSE6120 MKII Configuration Software Manual.</p> <p>The module detected that an analogue input configured as a digital input to create a fault condition became active and the appropriate LCD message is displayed.</p>
Calibration Fault	The module detected that its internal calibration has failed. The unit must be sent back to DSE to be investigated and repaired. Contact DSE Technical Support for more details.
Charge Alt Failure IEEE 37.2 – 27 DC Undervoltage Relay	The module detected that the output voltage of the charge alternator had fallen below the <i>Charge Alternator Warning Trip</i> level for the configured delay timer.
Coolant Temp High IEEE C37.2 – 26 Apparatus Thermal Device	The module detected that the engine coolant temperature had risen above the <i>High Coolant Temperature Pre-Alarm Trip</i> level after the <i>Safety On Delay</i> timer had expired.
DC Battery High Voltage IEEE 37.2 – 59 DC Overvoltage Relay	The module detected that its DC supply voltage had risen above the <i>Plant Battery Overvolts Warning Trip</i> level for the configured delay timer.
DC Battery Low Voltage IEEE 37.2 – 27 DC Undervoltage Relay	The module detected that its DC supply voltage had fallen below the <i>Plant Battery Undervolts Warning Trip</i> level for the configured delay timer.
DEF Level Low	The module received a fault condition from the engine ECU alerting about the DEF level or the module detected that the <i>DEF Level</i> had fallen below the <i>DEF Level Low Pre-Alarm Trip</i> level for the configured delay timer.
Digital Input A to F	<p>▲ NOTE: Due to module configuration the alarm message that appears on the display may be different. For further details of module configuration, refer to DSE Publication: 057-224 DSE6110 MKII & DSE6120 MKII Configuration Software Manual.</p> <p>The module detected that a digital input configured to create a fault condition became active and the appropriate LCD message is displayed.</p>
DPTC Filter	The module received a fault condition from the engine ECU alerting that the DPF/DPTC had activated.
ECU Amber	The module received an amber fault condition from the engine ECU.
ECU Data Fail	The module is configured for CAN operation but has not detected data being sent from the engine's ECU.
ECU Malfunc.	The module received a malfunction fault condition from the engine ECU.
ECU Protect	The module received a protect fault condition from the engine ECU.
ECU Red	The module received a red fault condition from the engine ECU.
Engine Over Speed IEEE C37.2 - 12 Overspeed Device	The module detected that the engine speed had risen above the <i>Over Speed Pre-Alarm Trip</i> level for the configured delay timer.

Continued over page...

Fault	Description
Engine Over Speed Delayed IEEE C37.2 - 12 Overspeed Device	The module detected that the engine speed had risen above the <i>Over Speed Trip</i> level but was below the <i>Over Speed Overshoot Trip</i> for the configured <i>Overshoot Delay</i> timer during starting.
Exp. Unit Failure	The module detected that communications to one of the DSENet® expansion modules had been lost.
Flexible Sensor A to D High	<div data-bbox="584 389 1399 568" style="border: 1px solid black; padding: 5px;"> <p>▲ NOTE: Due to module configuration the alarm message that appears on the display may be different. For further details of module configuration, refer to DSE Publication: 057-224 DSE6110 MKII & DSE6120 MKII Configuration Software Manual.</p> </div> <p>The module detected that an analogue input value had risen above the <i>Flexible Sensor High Pre-Alarm Trip</i> level.</p>
Flexible Sensor A to D Low	<div data-bbox="584 674 1399 853" style="border: 1px solid black; padding: 5px;"> <p>▲ NOTE: Due to module configuration the alarm message that appears on the display may be different. For further details of module configuration, refer to DSE Publication: 057-224 DSE6110 MKII & DSE6120 MKII Configuration Software Manual.</p> </div> <p>The module detected that an analogue input value had fallen below the <i>Flexible Sensor Low Pre-Alarm Trip</i> level.</p>
Failed to Stop IEEE C37.2 - 48 Incomplete Sequence Relay	<div data-bbox="584 958 1399 1081" style="border: 1px solid black; padding: 5px;"> <p>▲ NOTE: <i>Fail to Stop</i> could indicate a faulty oil pressure sensor. If engine is at rest, check the oil pressure sensor wiring and configuration.</p> </div> <p>The module detects a condition that indicates the generator is running when the DSE module has instructed it to stop.</p>
Fuel Level Low IEEE C37.2 - 71 Liquid Level Switch	The module detected that the engine fuel level had fallen below the <i>Fuel Level Low Pre-alarm Trip</i> level for the configured delay timer.
Fuel Level Low Switch IEEE C37.2 - 71 Liquid Level Switch	The module detected that the engine low fuel level switch had activated.
Fuel Level High IEEE C37.2 - 71 Liquid Level Switch	The module detected that the engine fuel level had risen above the <i>Fuel Level High Pre-alarm Trip</i> level for the configured delay timer.
Gen Over Current IEEE C37.2 – 50 Instantaneous Overcurrent Relay IEEE C37.2 – 51 IDMT Overcurrent Relay	<div data-bbox="584 1406 1399 1485" style="border: 1px solid black; padding: 5px;"> <p>▲ NOTE: For more details, see section entitled <i>Over Current Alarm</i> elsewhere in this document.</p> </div> <p>The module detected that the generator output current had risen above the <i>Generator Over Current Trip</i>.</p>
Gen Over Frequency IEEE C37.2 – 81 Frequency Relay	The module detected that the generator output frequency had risen above the <i>Over Frequency Pre-Alarm Trip</i> level for the configured delay timer.
Gen Over Frequency Delayed IEEE C37.2 – 81 Frequency Relay	The module detected that the generator output frequency had risen above the <i>Over Frequency Trip</i> level but was below the <i>Over Frequency Overshoot Trip</i> for the configured <i>Overshoot Delay</i> timer during starting.
Gen Over Voltage IEEE C37.2 – 59 AC Overvoltage Relay	The module detected that the generator output voltage had risen above the <i>Over Voltage Pre-Alarm Trip</i> level for the configured delay timer.

Continued over page...

Protections

Fault	Description
Gen Under Frequency IEEE C37.2 – 81 Frequency Relay	The module detected that the generator output frequency had fallen below the <i>Under Frequency Pre-Alarm Trip</i> level for the configured delay timer after the <i>Safety On Delay</i> timer had expired.
Gen Under Voltage IEEE C37.2 – 27 AC Undervoltage Relay	The module detected that the generator output voltage had fallen below the <i>Under Voltage Pre-Alarm Trip</i> level for the configured delay timer after the <i>Safety On Delay</i> timer had expired.
HEST Active	The module received a fault condition from the engine ECU alerting that the HEST had activated.
kW Overload IEEE C37.2 – 32 Directional Power Relay	The module detected that the generator output kW had risen above the <i>Overload Protection Trip</i> for the configured delay timer
Loss of Mag-PU	The module detected that the magnetic pick up was not producing a pulse output after the required <i>Crank Disconnect</i> criteria had been met.
Low Coolant Warning	The module detected that the engine coolant temperature had fallen below the <i>Low Coolant Temperature Pre-Alarm Trip</i> level.
Low Load	The module detected that the generator output kW had fallen below the <i>Low Load Alarm Trip</i> level for the configured delay timer.
Maintenance Due	 NOTE: Due to module configuration the alarm message that appears on the display may be different. For further details of module configuration, refer to DSE Publication: 057-224 DSE6110 MKII & DSE6120 MKII Configuration Software Manual.
	The module detected that one of the configured maintenance alarms is due as its configured maintenance interval has expired.
SCR Inducement	The module received a fault condition from the engine ECU alerting about the SCR Inducement.
Water in Fuel	The module received a fault condition from the engine ECU alerting that water in the fuel had been detected.

6.4 ELECTRICAL TRIP ALARMS

NOTE: The fault condition must be resolved before the alarm can be reset. If the fault condition remains, it is not possible to reset the alarm (the exception to this is the *Coolant Temp High* alarm and similar *Active From Safety On* alarms, as the coolant temperature could be high with the engine at rest).

Electrical Trip Alarms are latching and stop the Generator but in a controlled manner. On initiation of the electrical trip condition the module de-activates the **Close Gen Output** outputs to remove the load from the generator. Once this has occurred the module starts the *Cooling Timer* and allows the engine to cool off-load before shutting down the engine. To restart the generator the fault must be cleared and the alarm reset.

Example:

1/2 Alarms
Gen Over Current
Electrical Trip

In the event of an alarm the LCD jumps to the alarms page and scrolls through all active alarms.

Electrical Trip Alarms are latching alarms and to remove the fault, press the **Stop/Reset Mode**  button on the module.

Fault	Description
2130 ID 0 to 1 Analogue Input E to H High	<p>NOTE: Due to module configuration the alarm message that appears on the display may be different. For further details of module configuration, refer to DSE Publication: <i>057-224 DSE6110 MKII & DSE6120 MKII Configuration Software Manual</i>.</p> <p>The module detected that an analogue input value of a DSE2130 had risen above the <i>Flexible Sensor High Alarm Trip</i> level.</p>
2130 ID 0 to 1 Analogue Input E to H Low	<p>NOTE: Due to module configuration the alarm message that appears on the display may be different. For further details of module configuration, refer to DSE Publication: <i>057-224 DSE6110 MKII & DSE6120 MKII Configuration Software Manual</i>.</p> <p>The module detected that an analogue input value of a DSE2130 had fallen below the <i>Flexible Sensor Low Alarm Trip</i> level.</p>
2130 ID 0 to 1 Digital Input A to H	<p>NOTE: Due to module configuration the alarm message that appears on the display may be different. For further details of module configuration, refer to DSE Publication: <i>057-224 DSE6110 MKII & DSE6120 MKII Configuration Software Manual</i>.</p> <p>The module detected that a digital input configured to create a fault condition on a DSE2130 expansion module became active and the appropriate LCD message displayed.</p>

Continued over page...

Fault	Description
Analogue Input A to D (Digital)	<p>▲ NOTE: Due to module configuration the alarm message that appears on the display may be different. For further details of module configuration, refer to DSE Publication: 057-224 DSE6110 MKII & DSE6120 MKII Configuration Software Manual.</p> <p>The module detected that an analogue input configured as a digital input to create a fault condition became active and the appropriate LCD message is displayed.</p>
Calibration Fault	The module detected that its internal calibration has failed. The unit must be sent back to DSE to be investigated and repaired. Contact DSE Technical Support for more details.
Coolant Temp High IEEE C37.2 – 26 Apparatus Thermal Device	The module detected that the engine coolant temperature had risen above the <i>High Coolant Temperature Electrical Trip</i> level after the <i>Safety On Delay</i> timer had expired.
DEF Level Low	The module received a fault condition from the engine ECU alerting about the DEF level or the module detected that the <i>DEF Level</i> had fallen below the <i>DEF Level Low Alarm Trip</i> level for the configured delay timer.
Digital Input A to F	<p>▲ NOTE: Due to module configuration the alarm message that appears on the display may be different. For further details of module configuration, refer to DSE Publication: 057-224 DSE6110 MKII & DSE6120 MKII Configuration Software Manual.</p> <p>The module detected that a digital input configured to create a fault condition became active and the appropriate LCD message is displayed.</p>
DPTC Filter	The module received a fault condition from the engine ECU alerting that the DPF/DPTC had activated.
ECU Amber	The module received an amber fault condition from the engine ECU.
ECU Data Fail	The module is configured for CAN operation but has not detected data being sent from the engine's ECU.
ECU Malfunc.	The module received a malfunction fault condition from the engine ECU.
ECU Protect	The module received a protect fault condition from the engine ECU.
ECU Red	The module received a red fault condition from the engine ECU.
Exp. Unit Failure	The module detected that communications to one of the DSENet [®] expansion modules had been lost.

Continued over page...

Fault	Description
Flexible Sensor A to D High	<p>▲ NOTE: Due to module configuration the alarm message that appears on the display may be different. For further details of module configuration, refer to DSE Publication: 057-224 DSE6110 MKII & DSE6120 MKII Configuration Software Manual.</p> <p>The module detected that an analogue input value had risen above the <i>Flexible Sensor High Alarm Trip</i> level.</p>
Flexible Sensor A to D Low	<p>▲ NOTE: Due to module configuration the alarm message that appears on the display may be different. For further details of module configuration, refer to DSE Publication: 057-224 DSE6110 MKII & DSE6120 MKII Configuration Software Manual.</p> <p>The module detected that an analogue input value had fallen below the <i>Flexible Sensor Low Alarm Trip</i> level.</p>
Fuel Level Low IEEE C37.2 - 71 Liquid Level Switch	The module detected that the engine fuel level had fallen below the <i>Fuel Level Low Alarm Trip</i> level for the configured delay timer.
Fuel Level Low Switch IEEE C37.2 - 71 Liquid Level Switch	The module detected that the engine low fuel level switch had activated.
Fuel Level High IEEE C37.2 - 71 Liquid Level Switch	The module detected that the engine fuel level had risen above the <i>Fuel Level High Alarm Trip</i> level for the configured delay timer.
Fuel Usage IEEE C37.2 – 80 Flow Switch	The module detected that the fuel consumption was more then the configured Running Rate or Stopped Rate.
Gen Over Current IEEE C37.2 – 51 IDMT Overcurrent Relay	<p>▲ NOTE: For more details, see section entitled Over Current Alarm elsewhere in this document.</p> <p>The module detected that the generator output current had risen above the Generator Over Current Trip for the duration of the IDMT function.</p>
kW Overload IEEE C37.2 – 32 Directional Power Relay	The module detected that the generator output kW had risen above the Overload Protection Trip for the configured delay timer.
Low Load	The module detected that the generator output kW had fallen below the <i>Low Load Alarm Trip</i> level for the configured delay timer.
Loss of Mag-PU	The module detected that the magnetic pick up was not producing a pulse output after the required Crank Disconnect criteria had been met.
Maintenance Due	<p>▲ NOTE: Due to module configuration the alarm message that appears on the display may be different. For further details of module configuration, refer to DSE Publication: 057-224 DSE6110 MKII & DSE6120 MKII Configuration Software Manual.</p> <p>The module detected that one of the configured maintenance alarms is due as its configured maintenance interval has expired.</p>
SCR Inducement	The module received a fault condition from the engine ECU alerting about the SCR Inducement.
Water in Fuel	The module received a fault condition from the engine ECU alerting that water in the fuel had been detected.

6.5 SHUTDOWN ALARMS

▲ NOTE: The fault condition must be resolved before the alarm can be reset. If the fault condition remains, it is not possible to reset the alarm (the exception to this is the *Oil Pressure Low* alarm and similar *Active From Safety On* alarms, as the oil pressure is low with the engine at rest).

Shutdown Alarms are latching and immediately stop the Generator. On initiation of the shutdown condition the module de-activates the **Close Gen Output** outputs to remove the load from the generator. Once this has occurred, the module shuts the generator set down immediately to prevent further damage. To restart the generator the fault must be cleared and the alarm reset.

Example:

1/2	Alarm
Oil Pressure Low	
Shutdown	

In the event of an alarm the LCD jumps to the alarms page and scrolls through all active alarms.

Shutdown Alarms are latching alarms and to remove the fault, press the **Stop/Reset Mode**  button on the module.

Fault	Description
2130 ID 0 to 1 Analogue Input E to H High	<div style="border: 1px solid black; padding: 5px; margin-bottom: 5px;"> <p>▲ NOTE: Due to module configuration the alarm message that appears on the display may be different. For further details of module configuration, refer to DSE Publication: <i>057-224 DSE6110 MKII & DSE6120 MKII Configuration Software Manual</i>.</p> </div> <p>The module detected that an analogue input value of a DSE2130 had risen above the <i>Flexible Sensor High Alarm Trip</i> level.</p>
2130 ID 0 to 1 Analogue Input E to H Low	<div style="border: 1px solid black; padding: 5px; margin-bottom: 5px;"> <p>▲ NOTE: Due to module configuration the alarm message that appears on the display may be different. For further details of module configuration, refer to DSE Publication: <i>057-224 DSE6110 MKII & DSE6120 MKII Configuration Software Manual</i>.</p> </div> <p>The module detected that an analogue input value of a DSE2130 had fallen below the <i>Flexible Sensor Low Alarm Trip</i> level.</p>
2130 ID1 to 4 Digital Input A to H	<div style="border: 1px solid black; padding: 5px; margin-bottom: 5px;"> <p>▲ NOTE: Due to module configuration the alarm message that appears on the display may be different. For further details of module configuration, refer to DSE Publication: <i>057-224 DSE6110 MKII & DSE6120 MKII Configuration Software Manual</i>.</p> </div> <p>The module detected that a digital input configured to create a fault condition on a DSE2130 expansion module became active and the appropriate LCD message displayed.</p>



Continued over page...

Fault	Description
Analogue Input A to D (Digital)	<p>▲ NOTE: Due to module configuration the alarm message that appears on the display may be different. For further details of module configuration, refer to DSE Publication: 057-224 DSE6110 MKII & DSE6120 MKII Configuration Software Manual.</p> <p>The module detected that an analogue input configured as a digital input to create a fault condition became active and the appropriate LCD message is displayed.</p>
Calibration Fault	The module detected that its internal calibration has failed. The unit must be sent back to DSE to be investigated and repaired. Contact DSE Technical Support for more details.
Charge Alt Failure IEEE C37.2 – 27DC Undervoltage Relay	The module detected that the output voltage of the charge alternator had risen above the <i>Charge Alternator Shutdown Trip</i> level for the configured delay timer.
Coolant Temp High IEEE C37.2 – 26 Apparatus Thermal Device	The module detected that the engine coolant temperature had risen above the <i>High Coolant Temperature Shutdown Trip</i> level after the <i>Safety On Delay</i> timer had expired.
Coolant Temp High Switch IEEE C37.2 – 26 Apparatus Thermal Device	The module detected that the high engine coolant temperature switch had activated after the <i>Safety On Delay</i> timer had expired.
DEF Level	The module received a fault condition from the engine ECU alerting about the DEF level or the module detected that the <i>DEF Level</i> had fallen below the <i>DEF Level Low Alarm Trip</i> level for the configured delay timer.
Digital Input A to F	<p>▲ NOTE: Due to module configuration the alarm message that appears on the display may be different. For further details of module configuration, refer to DSE Publication: 057-224 DSE6110 MKII & DSE6120 MKII Configuration Software Manual.</p> <p>The module detected that a digital input configured to create a fault condition became active and the appropriate LCD message is displayed.</p>
DPTC Filter	The module received a fault condition from the engine ECU alerting that the DPF/DPTC had activated.
ECU Amber	The module received an amber fault condition from the engine ECU.
ECU Data Fail	The module is configured for CAN operation but has not detected data being sent from the engine's ECU.
ECU Malfunc.	The module received a malfunction fault condition from the engine ECU.
ECU Protect	The module received a protect fault condition from the engine ECU.
ECU Red	The module received a red fault condition from the engine ECU.

Continued over page...

Fault	Description
Emergency Stop IEEE C37.2 - 5 Stopping Device	The module detected that emergency stop button had been pressed removing a positive voltage supply from the emergency stop input terminal. This input is failsafe (normally closed to emergency stop) and immediately stops the generator when the signal is removed.
Engine Over Speed IEEE C37.2 - 12 Overspeed Device	The module detected that the engine speed had risen above the <i>Over Speed Alarm Trip</i> level for the configured delay timer.
Engine Over Speed Overshoot IEEE C37.2 - 12 Overspeed Device	The module detected that the engine speed had risen above the <i>Over Speed Overshoot Trip</i> during the configured <i>Overshoot Delay</i> timer whilst starting.
Engine Under Speed IEEE C37.2 - 14 Underspeed Device	The module detected that the engine speed had fallen below the <i>Under Speed Alarm Trip</i> level for the configured delay timer after the <i>Safety On Delay</i> timer had expired.
Exp. Unit Failure	The module detected that communications to one of the DSENet® expansion modules had been lost.
Failed to Start IEEE C37.2 - 48 Incomplete Sequence Relay	The module detected that the generator had failed to start as it did not meet the required Crank Disconnect criteria during the configured number of Crank Attempts.
Flexible Sensor A to D High	<div style="border: 1px solid black; padding: 5px;"> <p>▲ NOTE: Due to module configuration the alarm message that appears on the display may be different. For further details of module configuration, refer to DSE Publication: 057-224 DSE6110 MKII & DSE6120 MKII Configuration Software Manual.</p> </div>
	The module detected that an analogue input value had risen above the <i>Flexible Sensor High Alarm Trip</i> level.
Flexible Sensor A to D Low	<div style="border: 1px solid black; padding: 5px;"> <p>▲ NOTE: Due to module configuration the alarm message that appears on the display may be different. For further details of module configuration, refer to DSE Publication: 057-224 DSE6110 MKII & DSE6120 MKII Configuration Software Manual.</p> </div>
	The module detected that an analogue input value had fallen below the <i>Flexible Sensor Low Alarm Trip</i> level.
Fuel Level Low IEEE C37.2 - 71 Liquid Level Switch	The module detected that the engine fuel level had fallen below the <i>Fuel Level Low Alarm Trip</i> level for the configured delay timer.
Fuel Level Low Switch IEEE C37.2 - 71 Liquid Level Switch	The module detected that the engine low fuel level switch had activated.
Fuel Level High IEEE C37.2 - 71 Liquid Level Switch	The module detected that the engine fuel level had risen above the <i>Fuel Level High Alarm Trip</i> level for the configured delay timer.

Continued over page...

Fault	Description
Gen Over Current IEEE C37.2 – 51 IDMT Overcurrent Relay	<div style="border: 1px solid black; padding: 5px;">  NOTE: For more details, see section entitled Over Current Alarm elsewhere in this document. </div> <p>The module detected that the generator output current had risen above the <i>Generator Over Current Trip</i> for the duration of the IDMT function.</p>
Gen Over Frequency IEEE C37.2 – 81 Frequency Relay	<p>The module detected that the generator output frequency had risen above the <i>Over Frequency Alarm Trip</i> level for the configured delay timer.</p>
Gen Over Frequency Overshoot IEEE C37.2 – 81 Frequency Relay	<p>The module detected that the generator output frequency had risen above the <i>Over Frequency Overshoot Trip</i> during the configured <i>Overshoot Delay</i> timer whilst starting.</p>
Gen Over Voltage IEEE C37.2 – 59 AC Overvoltage Relay	<p>The module detected that the generator output voltage had risen above the <i>Over Voltage Alarm Trip</i> level for the configured delay timer.</p>
Gen Under Frequency IEEE C37.2 – 81 Frequency Relay	<p>The module detected that the generator output frequency had fallen below the <i>Under Frequency Alarm Trip</i> level for the configured delay timer after the <i>Safety On Delay</i> timer had expired.</p>
Gen Under Voltage IEEE C37.2 – 27 AC Undervoltage Relay	<p>The module detected that the generator output voltage had fallen below the <i>Under Voltage Alarm Trip</i> level for the configured delay timer after the <i>Safety On Delay</i> timer had expired.</p>
kW Overload IEEE C37.2 – 32 Directional Power Relay	<p>The module detected that the generator output kW had risen above the <i>Overload Protection Trip</i> for the configured delay timer.</p>
Low Load	<p>The module detected that the generator output kW had fallen below the <i>Low Load Alarm Trip</i> level for the configured delay timer.</p>
Loss of Mag-PU	<p>The module detected that the magnetic pick up was not producing a pulse output after the required <i>Crank Disconnect</i> criteria had been met.</p>
Mag-PU Fault	<p>The module detected that circuit to the magnetic pick up sensor had become open circuit.</p>
Maintenance Due	<div style="border: 1px solid black; padding: 5px;">  NOTE: Due to module configuration the alarm message that appears on the display may be different. For further details of module configuration, refer to DSE Publication: 057-224 DSE6110 MKII & DSE6120 MKII Configuration Software Manual. </div> <p>The module detected that one of the configured maintenance alarms is due as its configured maintenance interval has expired.</p>
Oil Press Sender Fault	<p>The module detected that circuit to the engine oil pressure sensor had become open circuit.</p>
Oil Pressure Low IEEE C37.2 - 63 Pressure Switch	<p>The module detected that the engine oil pressure had fallen below the <i>Low Oil Pressure Shutdown Trip</i> level after the <i>Safety On Delay</i> timer had expired.</p>
Oil Pressure Low Switch IEEE C37.2 - 63 Pressure Switch	<p>The module detected that the low oil pressure switch had activated after the <i>Safety On Delay</i> timer had expired.</p>
SCR Inducement	<p>The module received a fault condition from the engine ECU alerting about the SCR Inducement.</p>
Water in Fuel	<p>The module received a fault condition from the engine ECU alerting that water in the fuel had been detected.</p>

6.6 MAINTENANCE ALARMS

Depending upon module configuration one or more levels of engine maintenance alarm may occur based upon a configurable schedule.

Example 1:

Screen capture from DSE Configuration Suite Software showing the configuration of the Maintenance Alarm for 1, 2 and 3.

When activated, the maintenance alarm can be either a **warning** (set continues to run) or **shutdown** (running the set is not possible).

Resetting the maintenance alarm is normally actioned by the site service engineer after performing the required maintenance.

The method of reset is either by:

Activating an input that has been configured to Maintenance Reset Alarm 1, 2 or 3.

Pressing the maintenance reset button in the DSE Configuration Suite, Maintenance section.

Pressing and holding the **Stop/Reset Mode**  button for 10 seconds on the desired Maintenance Alarm status page. This may be protected by a PIN number.

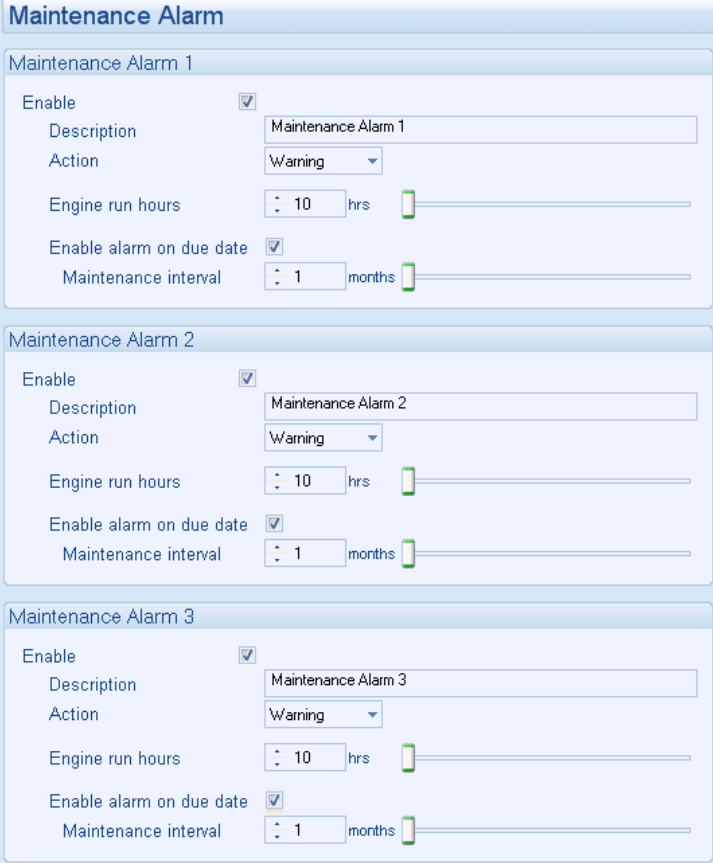

The screenshot shows the 'Maintenance Alarm' configuration window with three sections: Maintenance Alarm 1, Maintenance Alarm 2, and Maintenance Alarm 3. Each section has the following fields:

- Enable:** A checked checkbox.
- Description:** A text box containing the alarm name (e.g., 'Maintenance Alarm 1').
- Action:** A dropdown menu set to 'Warning'.
- Engine run hours:** A numeric input set to '10' with 'hrs' and a slider.
- Enable alarm on due date:** A checked checkbox.
- Maintenance interval:** A numeric input set to '1' with 'months' and a slider.

Example 2:

Screen capture from DSE Configuration Suite Software showing the configuration of a digital input for Reset Maintenance Alarm.

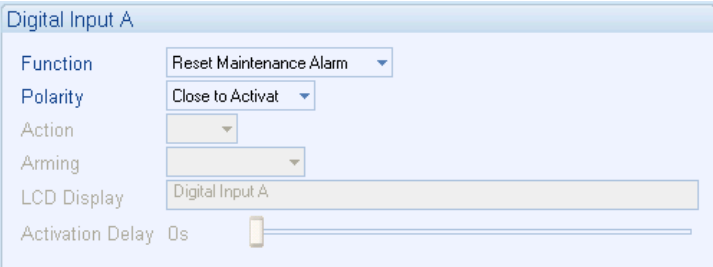

The screenshot shows the 'Digital Input A' configuration window with the following fields:

- Function:** A dropdown menu set to 'Reset Maintenance Alarm'.
- Polarity:** A dropdown menu set to 'Close to Activat'.
- Action:** A dropdown menu.
- Arming:** A dropdown menu.
- LCD Display:** A text box containing 'Digital Input A'.
- Activation Delay:** A slider set to '0s'.

Example 3:

Screen capture from DSE Configuration Suite Software showing the Maintenance Alarm Reset 'button' in the DSE Configuration Suite SCADA | MAINTENANCE section.

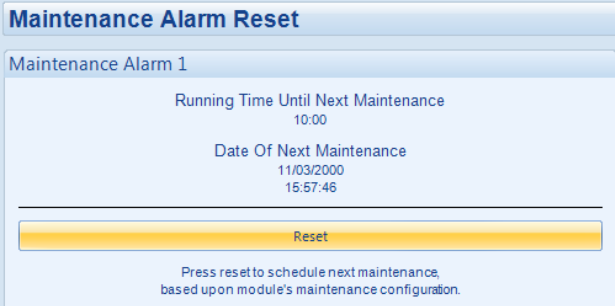

The screenshot shows the 'Maintenance Alarm Reset' status page for Maintenance Alarm 1. It displays the following information:

- Running Time Until Next Maintenance:** 10:00
- Date Of Next Maintenance:** 11/03/2000 15:57:46
- Reset:** A large yellow button.
- Text below button:** 'Press reset to schedule next maintenance, based upon module's maintenance configuration.'

6.7 OVER CURRENT ALARM

The *Over Current Alarm* combines a simple warning trip level with a fully functioning IDMT curve for thermal protection.

6.7.1 IMMEDIATE WARNING

If the *Immediate Warning* is enabled, the controller generates a *warning alarm* as soon as the *Trip* level is reached. The alarm automatically resets once the generator loading current falls below the *Trip* level (unless *All Warnings are latched* is enabled). For further advice, consult the generator supplier.

6.7.2 INVERSE DEFINITE MINIMUM TIME (IDMT) ALARM

If the *Over Current IDMT Alarm* is enabled, the controller begins following the IDMT 'curve' when the current on any phase passes the *Trip* setting.

If the *Trip* is surpassed for an excess amount of time, the *IDMT Alarm* triggers (*Shutdown* or *Electrical Trip* as selected in *Action*).

The larger the over circuit fault, the faster the trip. The speed of the trip is dependent upon the fixed formula:

$$T = \frac{t}{\left(\frac{I_A}{I_T} - 1\right)^2}$$

Where:

- T* is the tripping time in seconds
- I_A* is the actual measured current of the most highly loaded line (L1, L2 or L3)
- I_T* is the delayed trip point setting in current
- t* is the time multiplier setting and also represents the tripping time in seconds at twice full load (when $I_A/I_T = 2$).

The settings shown in the example below are a screen capture of the DSE factory settings, taken from the DSE Configuration Suite PC Software for a brushless alternator.

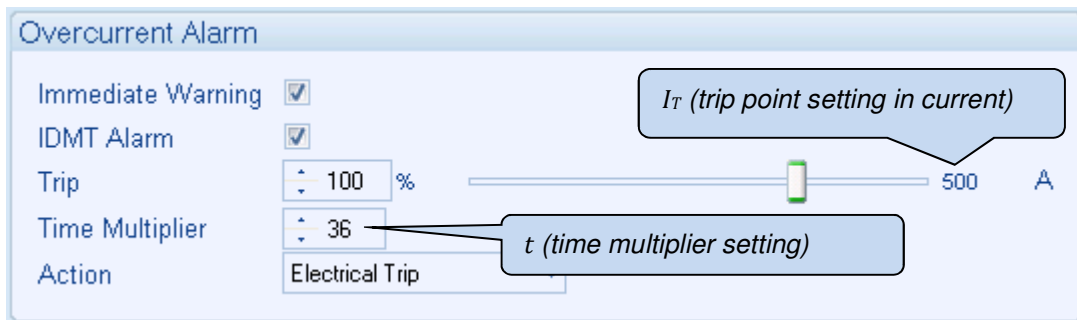

These settings provide for normal running of the generator up to 100% full load. If full load is surpassed, the *Immediate Warning* alarm is triggered and the set continues to run.

The effect of an overload on the generator is that the alternator windings begin to overheat; the aim of the *IDMT Alarm* is to prevent the windings being overload (heated) too much. The amount of time that the alternator can be safely overloaded is governed by how high the overload condition is.

The default settings as shown above allow for an overload of the alternator to the limits of the *Typical Brushless Alternator* whereby 110% overload is permitted for 1 hour or 200% overload is permitted for 36 seconds.

If the alternator load reduces, the controller then follows a cooling curve. This means that a second overload condition may trip soon after the first as the controller knows if the windings have not cooled sufficiently.

For further details on the *Thermal Damage Curve* of your alternator, refer to the alternator manufacturer and generator supplier.

6.7.2.1 CREATING A SPREADSHEET FOR THE OVER CURRENT IDMT CURVE

The formula used:

$$T = \frac{t}{\left(\frac{I_A}{I_T} - 1\right)^2}$$

Where:

T is the tripping time in seconds

I_A is the actual measured current of the most highly loaded line (L1, L2 or L3)

I_T is the delayed trip point setting in current

t is the time multiplier setting and also represents the tripping time in seconds at twice full load (when $I_A/I_T = 2$).

The equation can be simplified for addition into a spreadsheet. This is useful for ‘trying out’ different values of t (*time multiplier setting*) and viewing the results, without actually testing this on the generator.

	A	B	C	D	E	F
1		1.01	1.02	1.03	1.05	1.06
2	36	360000	90000	40000	14400	10000

I_A/I_T (multiple of the Trip setting from 1.01 to 3.0 in steps of 0.1)

t (time multiplier setting)

T (tripping time in seconds)

The formula for the *Tripping Time* cells is:

`=A2/POWER((B$1-1),2)`

Over Current IDMT Alarm Curves

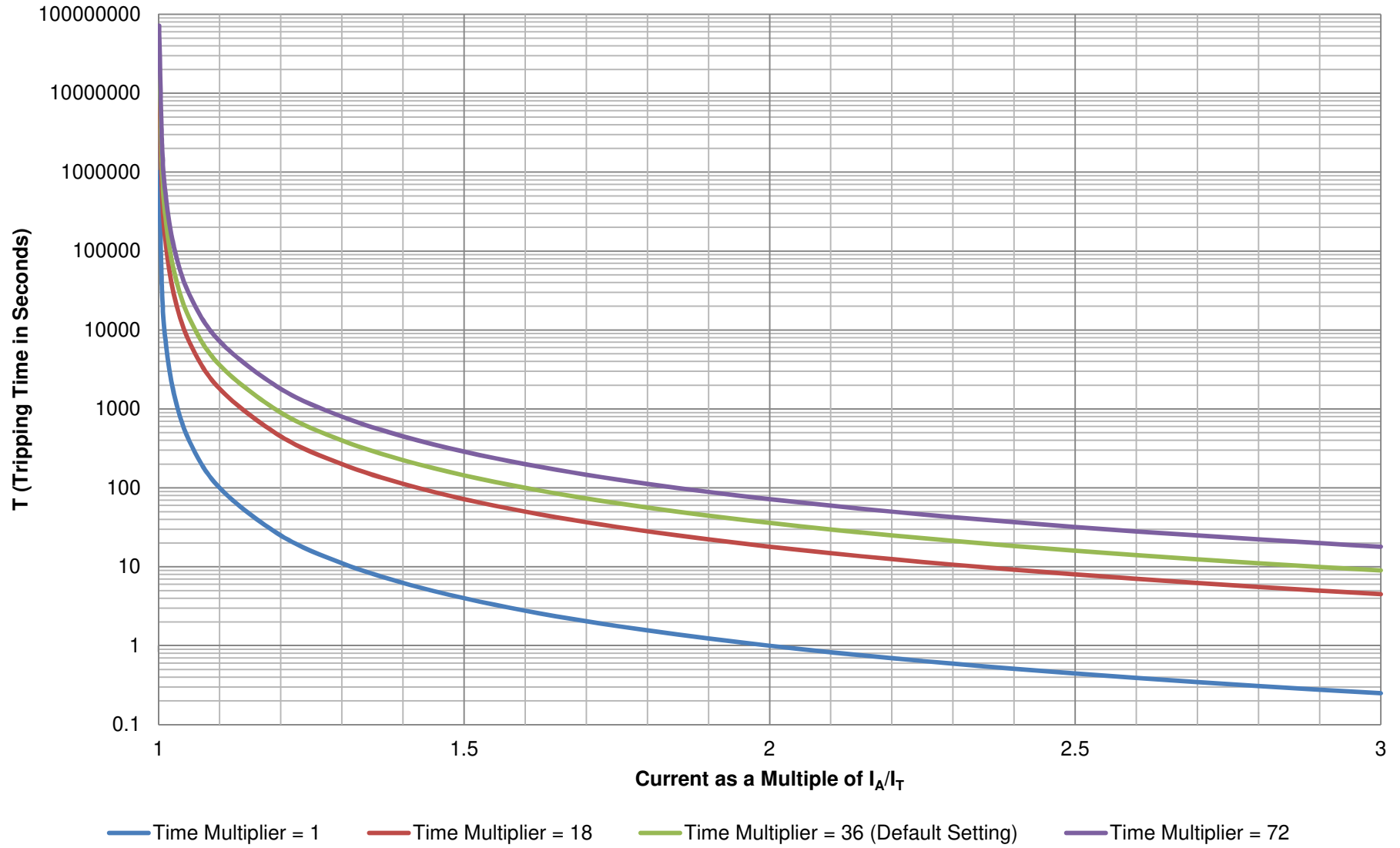

7 FRONT PANEL CONFIGURATION

This configuration mode allows the operator to fully configure the module through its display without the use of the DSE Configuration Suite PC Software.

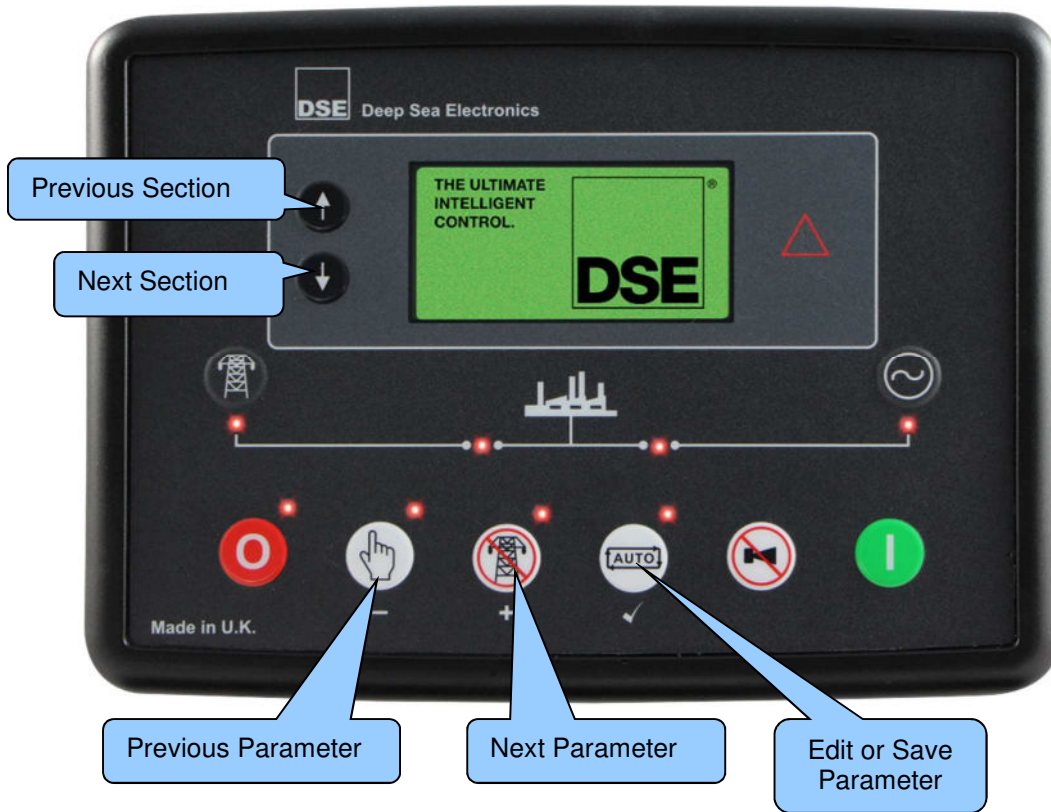

Use the module's facia buttons to traverse the menu and make value changes to the parameters:



7.1 MAIN CONFIGURATION EDITOR

7.1.1 ACCESSING THE MAIN CONFIGURATION EDITOR





 **NOTE:** More comprehensive module configuration is possible via PC configuration software. For further details of module configuration, refer to DSE Publication: 057- 224 DSE6110 MKII & DSE6110 MKII Configuration Software Manual.

- Ensure the engine is at rest and the module by pressing the **Stop/Reset Mode**  button.
- Press the **Stop/Reset Mode**  and **Tick**  buttons together to enter the main configuration editor.



7.1.2 ENTERING PIN









 **NOTE:** The PIN is not set by DSE when the module leaves the factory. If the module has a PIN code set, this has been affected by your engine supplier who should be contacted if you require the code. If the code has been 'lost' or 'forgotten', the module must be returned to the DSE factory to have the module's code removed. A charge is made for this procedure. NB - This procedure cannot be performed away from the DSE factory.

 **NOTE:** The PIN is automatically reset when the editor is exited (manually or automatically) to ensure security.

- If a module security PIN has been set, the PIN request is then shown.
- Press the **Tick**  button, the first '#' changes to '0'. Press the **Previous -** & **Next +** buttons to adjust it to the correct value.
- Press the **Scroll Down**  button when the first digit is correctly entered. The digit previously entered now shows as '#' for security.
- Repeat this process for the other digits of the PIN. Press the **Scroll Up**  button to move back to adjust one of the previous digits.
- After editing the final PIN digit, press the **Tick**  button. The PIN is then checked for validity. If the number is not correct, the PIN must re-entered.
- If the PIN has been successfully entered (or the module PIN has not been enabled), the editor is displayed.



7.1.3 EDITING A PARAMETER

 **NOTE:** Pressing and holding either the *Menu Navigation*   buttons provides the auto-repeat functionality. Values can be changed quickly by holding the navigation buttons for a prolonged period of time.

- Press and hold either of the *Menu Navigation*   buttons to cycle to the section which is required to be edited.
- Press the *Menu Navigation*   buttons to cycle to the parameter within the section chosen to be edited.
- Press the *Tick*  button to edit the parameter. The parameter begins to flash to indicate that the parameter is being edited.
- Press the *Previous*  & *Next*  buttons to adjust the parameter to the required value.
- Press the *Tick*  button to stop editing the parameter. The parameter ceases flashing to indicate that it the parameter is no longer being edited.

7.1.4 EXITING THE FRONT PANEL CONFIGURATION EDITOR

 **NOTE:** The editor automatically exits after 5 minutes of inactivity to ensure security.

- Press and hold the *Stop/Reset Mode*  button to exit the editor without saving changes.
- Press and hold the *Tick*  button to exit the editor and save the changes.

7.1.5 ADJUSTABLE PARAMETERS

Section	Parameter As Shown On Display	Value
Display	Contrast	0 %
	Language	English
	LCD Page Delay	0 h 0 m 0 s
	LCD Scroll Delay	0 h 0 m 0 s
	Current Date and Time	Date, Month, Year, hh:mm
Engine	Oil Pressure Low Shutdown	0.00 bar
	Coolant Temperature High Pre Alarm	0 °C
	Coolant Temperature High Shutdown	0 °C
	Start Delay	0 h 0 m 0 s
	Pre Heat Timer	0 h 0 m 0 s
	Cranking	0 m 0 s
	Crank Rest	0 m 0 s
	Safety On Delay	0 m 0 s
	Smoke Limiting	0 m 0 s
	Smoke Limiting Off	0 m 0 s
	Warming	0 h 0 m 0 s
	Cooling	0 h 0 m 0 s
	Under Speed Shutdown	Active / Inactive
	Under Speed Shutdown	0 RPM
	Under Speed Shutdown Delay	0.0 s
	Engine Over Speed Warning	Active / Inactive
	Engine Over Speed Warning	0 RPM
	Engine Over Speed Shutdown	0 RPM
	Engine Over Speed Shutdown Delay	0.0 s
	Overspeed Overshoot	0.0s
	Fail to Stop Delay	0 m 0 s
	Battery Under Voltage Warning	Active / Inactive
	Battery Under Voltage Warning	0 V
	Battery Under Voltage Warning Delay	0 h 0 m 0 s
	Battery Over Voltage Warning	Active / Inactive
	Battery Over Voltage Warning	0 V
	Battery Over Voltage Warning Delay	0 h 0 m 0 s
	Charge Alternator Failure Warning	Active / Inactive
	Charge Alternator Failure Warning	0 V
	Charge Alternator Warning Delay	0 h 0 m 0 s
	Charge Alternator Failure Shutdown	Active / Inactive
	Charge Alternator Failure Shutdown	0.0 V
	Charge Alternator Shutdown Delay	0 h 0 m 0 s
Low Battery Start	Active / Inactive	
Low Battery Level	0.0 V	
Low Battery Start Delay	0 h 0 m 0 s	
Low Battery Run Time	0 h 0 m 0 s	
Generator	Under Voltage Shutdown	0 V
	Under Voltage Shutdown Delay	0.0 s
	Under Voltage Pre Alarm	0 V
	Loading Voltage	0 V
	Nominal Voltage	0 V
	Over Voltage Pre Alarm	0 V
	Over Voltage Shutdown	0 V
	Over Voltage Shutdown Delay	0.0 s
	Under Frequency Shutdown	0.0 Hz
	Under Frequency Shutdown Delay	0.0 s
	Under Frequency Pre Alarm	0.0 Hz

Front Panel Configuration

Section	Parameter As Shown On Display	Value
Generator (Continued)	Loading Frequency	0.0 Hz
	Nominal Frequency	0.0 Hz
	Over Frequency Pre Alarm	0.0 Hz
	Over Frequency Shutdown	0.0 Hz
	Over Frequency Shutdown Delay	0.0 s
	Over Frequency Overshoot	0.0 s
	Full Load Rating	0 A
	Delayed Over Current	Active / Inactive
	Delayed Over Current	0 %
	AC System	3 Phase, 4 Wire
	CT Primary	0 A
	Full Load Rating	0 kW
	kW Overload Trip	0 %
	kW Overload Return	0 %
	Full Load Rating Delay	0 h 0 m 0 s
Mains DSE6120 MKII Only	Under Voltage Trip	0 V
	Over Voltage Trip	0 V
	Under Frequency Trip	0.0 Hz
	Over Frequency Trip	0.0 Hz
	Transient Delay	0 m 0 s
	Return Delay	0 h 0 m 0 s
	Transfer Time	0 m 0.0 s
Timers	LCD Page Delay	0 h 0 m 0 s
	LCD Scroll Delay	0 h 0 m 0 s
	Engine Pre Heat Timer	0 h 0 m 0 s
	Engine Cranking	0 m 0 s
	Engine Crank Rest	0 m 0 s
	Engine Safety On Delay	0 m 0 s
	Engine Smoke Limiting	0 m 0 s
	Engine Smoke Limiting Off	0 m 0 s
	Engine Warming	0 h 0 m 0 s
	Engine Cooling	0 h 0 m 0 s
	Engine Fail To Stop Delay	0 m 0 s
	Battery Under Voltage Warning Delay	0 h 0 m 0 s
	Battery Over Voltage Warning Delay	0 h 0 m 0 s
	Return Delay	0 h 0 m 0 s
	Mains Transient Delay	0 m 0 s
Mains Transfer Time	0 m 0.0 s	
Schedule	Schedule	Active / Inactive
	Schedule Period	Weekly / Monthly,
	On Load / Off Load / Auto Start Inhibit, Week, Start Time, Run Time and Day Selection (1-8)	Press ✓ (Tick) to begin editing then press + (Plus) or - (Minus) when selecting the different parameters.

7.2 'RUNNING' CONFIGURATION EDITOR

7.2.1 ACCESSING THE 'RUNNING' CONFIGURATION EDITOR

- The 'running' editor can be entered whilst the engine is running. All protections remain active if the engine is running while the running editor is entered
- Press and hold together the **Menu Navigation**   buttons to access the *Running Editor*





7.2.2 ENTERING PIN

 **NOTE:** The PIN is not set by DSE when the module leaves the factory. If the module has a PIN code set, this has been affected by your engine supplier who should be contacted if you require the code. If the code has been 'lost' or 'forgotten', the module must be returned to the DSE factory to have the module's code removed. A charge is made for this procedure.
NB - This procedure cannot be performed away from the DSE factory.

 **NOTE:** The PIN is automatically reset when the editor is exited (manually or automatically) to ensure security.



- Even if a module security PIN has been set, the PIN is not requested whilst entering the 'running' editor.

7.2.3 EDITING A PARAMETER

- Press either of the **Menu Navigation**   buttons to cycle to the parameter within the section chosen to be edited.
- Press the **Tick**  button to edit the parameter. The parameter begins to flash to indicate that the parameter is being edited.
- Press the **Previous - & Next +** buttons to adjust the parameter to the required value.
- Press the **Tick**  button to stop editing the parameter. The parameter ceases flashing to indicate that it the parameter is no longer being edited

7.2.4 EXITING THE 'RUNNING' CONFIGURATION EDITOR

 **NOTE: The editor automatically exits after 5 minutes of inactivity to ensure security.**

- Press and hold the **Stop/Reset Mode**  button to exit the editor without saving changes.
- Press and hold the **Tick**  button to exit the editor and save the changes.

7.2.5 RUNNING EDITOR PARAMETERS

Section	Parameter As Shown On Display	Values
Display	Contrast	0 %
	Language	English

8 COMMISSIONING



 **NOTE: If Emergency Stop feature is not required, link the input to the DC Positive.**

Before the system is started, it is recommended that the following checks are made:



The unit is adequately cooled and all the wiring to the module is of a standard and rating compatible with the system. Check all mechanical parts are fitted correctly and that all electrical connections (including earths) are sound.

The unit DC supply is fused and connected to the battery and that it is of the correct polarity.

The Emergency Stop input is wired to an external normally closed switch connected to DC positive.

To check the start cycle operation, take appropriate measures to prevent the engine from starting (disable the operation of the fuel solenoid). After a visual inspection to ensure it is safe to proceed, connect the battery supply. Press the **Manual Mode**  button followed by the **Start**  button the unit start sequence commences.

The starter engages and operates for the pre-set crank period. After the starter motor has attempted to start the engine for the pre-set number of attempts, the LCD displays *Failed to Start*. Press the **Stop/Reset Mode**  button to reset the unit.

Restore the engine to operational status (reconnect the fuel solenoid). Press the **Manual Mode**  button followed by the **Start**  button. This time the engine should start and the starter motor should disengage automatically. If not then check that the engine is fully operational (fuel available, etc.) and that the fuel solenoid is operating. The engine should now run up to operating speed. If not, and an alarm is present, check the alarm condition for validity, then check input wiring. The engine should continue to run for an indefinite period. It is possible at this time to view the engine and alternator parameters - refer to the 'Description of Controls' section of this manual.

Press the **Auto Mode**  button, the engine runs for the pre-set cooling down period, then stop. The generator should stay in the standby mode. If it does not, check that the *Remote Start* input is not active.

Initiate an automatic start by supplying the remote start signal (if configured). The start sequence commences and the engine runs up to operational speed. Once the generator is available the delayed load outputs activate, the Generator accepts the load. If not, check the wiring to the delayed load output contactors. Check the Warming timer has timed out.

Remove the remote start signal. The return sequence begins. After the pre-set time, the generator is unloaded. The generator then runs for the pre-set cooling down period, then shutdown into its standby mode.

Set the modules internal clock/calendar to ensure correct operation of the scheduler and event logging functions. For details of this procedure see section entitled *Front Panel Configuration*.

If, despite repeated checking of the connections between the controller and the customer's system, satisfactory operation cannot be achieved, then contact DSE Technical Support Department:

Tel: +44 (0) 1723 890099
Fax: +44 (0) 1723 893303
E-mail: support@deepseapl.com
Website: www.deepseapl.com

9 FAULT FINDING

 **NOTE:** The below fault finding is provided as a guide check-list only. As the module can be configured to provide a wide range of different features, always refer to the source of your module configuration if in doubt.

9.1 STARTING

Symptom	Possible Remedy
Unit is inoperative	Check the battery and wiring to the unit. Check the DC supply. Check the DC fuse.
Read/Write configuration does not operate	
Unit shuts down	Check DC supply voltage is not above 35 Volts or below 9 Volts Check the operating temperature is not above 70°C. Check the DC fuse.
Fail to Start is activated after pre-set number of attempts to start	Check wiring of fuel solenoid. Check fuel. Check battery supply. Check battery supply is present on the Fuel output of the module. Check the speed-sensing signal is present on the module's inputs. Refer to engine manual.
Continuous starting of generator when in the Auto Mode 	Check that there is no signal present on the "Remote Start" input. Check configured polarity is correct. Check the mains supply is available and within configured limits
Generator fails to start on receipt of Remote Start signal.	Check Start Delay timer has timed out. Check signal is on "Remote Start" input. Confirm correct configuration of input is configured to be used as "Remote Start". Check that the oil pressure switch or sensor is indicating low oil pressure to the controller. Depending upon configuration, the set does not start if oil pressure is not low.
Pre-heat inoperative	Check wiring to engine heater plugs. Check battery supply. Check battery supply is present on the Pre-heat output of module. Check pre-heat configuration is correct.
Starter motor inoperative	Check wiring to starter solenoid. Check battery supply. Check battery supply is present on the Starter output of module. Ensure oil pressure switch or sensor is indicating the "low oil pressure" state to the controller.

9.2 LOADING

Symptom	Possible Remedy
Engine runs but generator does not take load	Check Warm up timer has timed out. Ensure generator load inhibit signal is not present on the module inputs. Check connections to the switching device. Note that the set does not take load in Manual Mode  unless there is an active load signal.
Incorrect reading on Engine gauges	Check engine is operating correctly.
Fail to stop alarm when engine is at rest	Check that sensor is compatible with the module and that the module configuration is suited to the sensor.

9.3 ALARMS

Symptom	Possible Remedy
Oil pressure low fault operates after engine has fired	Check engine oil pressure. Check oil pressure switch/sensor and wiring. Check configured polarity (if applicable) is correct (i.e. Normally Open or Normally Closed) or that sensor is compatible with the module and is correctly configured.
Coolant temp high fault operates after engine has fired.	Check engine temperature. Check switch/sensor and wiring. Check configured polarity (if applicable) is correct (i.e. Normally Open or Normally Closed) or that sensor is compatible with the module.
Shutdown fault operates	Check relevant switch and wiring of fault indicated on LCD display. Check configuration of input.
Electrical Trip fault operates	Check relevant switch and wiring of fault indicated on LCD display. Check configuration of input.
Warning fault operates	Check relevant switch and wiring of fault indicated on LCD display. Check configuration of input.
ECU Amber ECU Red	This indicates a fault condition detected by the engine ECU and transmitted to the DSE controller.
ECU Data Fail	Indicates failure of the CAN data link to the engine ECU. Check all wiring and termination resistors (if required).
Incorrect reading on Engine gauges	Check engine is operating correctly. Check sensor and wiring paying particular attention to the wiring to terminal 14.
Fail to stop alarm when engine is at rest	Check that sensor is compatible with the module and that the module configuration is suited to the sensor.

9.4 COMMUNICATIONS

Symptom	Possible Remedy
ECU Data Fail	Indicates failure of the CAN data link to the engine ECU. Check all wiring and termination resistors (if required).

9.5 INSTRUMENTS

Symptom	Possible Remedy
Inaccurate generator measurements on controller display	<p>Check that the CT primary, CT secondary and VT ratio settings are correct for the application.</p> <p>Check that the CTs are wired correctly with regards to the direction of current flow (p1,p2 and s1,s2) and additionally ensure that CTs are connected to the correct phase (errors occur if CT1 is connected to phase 2).</p> <p>Remember to consider the power factor ($kW = kVA \times \text{powerfactor}$).</p> <p>The controller is true RMS measuring so gives more accurate display when compared with an 'averaging' meter such as an analogue panel meter or some lower specified digital multimeters.</p> <p>Accuracy of the controller is better than 1% of full scale. Generator voltage full scale is 415 V ph-N, accuracy is ± 4.15 V (1 % of 415 V).</p>

9.6 MISCELLANEOUS

Symptom	Possible Remedy
Module appears to 'revert' to an earlier configuration	<p>When editing a configuration using the PC software it is vital that the configuration is first 'read' from the controller before editing it. This edited configuration must then be "written" back to the controller for the changes to take effect.</p> <p>When editing a configuration using the fascia editor, be sure to press the Tick  button to save the change before moving to another item or exiting the fascia editor</p>

10 MAINTENANCE, SPARES, REPAIR AND SERVICING

The controller is *Fit and Forget*. As such, there are no user serviceable parts within the controller. In the case of malfunction, you should contact your original equipment manufacturer (OEM).









10.1 PURCHASING ADDITIONAL CONNECTOR PLUGS FROM DSE

If you require additional plugs from DSE, please contact our Sales department using the part numbers below.

10.1.1 PACK OF PLUGS

Module Type	Plug Pack Part Number
DSE6110 MKII	007-869
DSE6120 MKII	007-870

10.1.2 INDIVIDUAL PLUGS

Module Terminal Designation	Plug Description	Part No.
1-10 	10 way 5.08 mm	007-450
11-21 	11 way 5.08 mm	007-451
22-24 	3 way 5.08 mm	007-174
25-28  DSE6110 MKII Only	4 way 7.62 mm	007-171
25-32  DSE6120 MKII Only	8 way 7.62 mm	007-454
33-37 	5 way 5.08 mm	007-445
38-43 	6 way 5.08 mm	007-446
	PC Configuration interface lead (USB type A – USB type B)	016-125

10.2 PURCHASING ADDITIONAL FIXING CLIPS FROM DSE

Item	Description	Part No.
	Module Fixing Clips (Packet Of 2)	020-406



10.3 PURCHASING ADDITIONAL SEALING GASKET FROM DSE

Item	Description	Part No.
	Module Silicon Sealing Gasket	020-521

10.4 DSENET® EXPANSION MODULES

NOTE: A maximum of six (6) expansion modules can be connected to the DSE6110 MKII & DSE6120 MKII DSENet® Port

NOTE: DSENet® utilises an RS485 connection. Using Belden 9841 (or equivalent) cable allows for the expansion cable to be extended to a maximum of 1.2km. DSE Stock and supply Belden 9841 cable. DSE Part Number 016-030.

Item	Max No. Supported	Description	DSE Part Numbers		
			Model Order Number	Operator Manual	Installation Instructions
	2	Model DSE2130 input module provides additional analogue and digital inputs for use with the controller.	2130-00	057-082	053-033
	2	Model DSE2157 expansion relay module provides eight additional voltage free relays for use with the controller	2157-00	057-083	053-034
	2	Model DSE2548 expansion LED module provides additional LED indications, internal sounder and remote lamp test/alarm mute for use with the controller.	2548-00	057-084	053-032

11 WARRANTY

DSE Provides limited warranty to the equipment purchaser at the point of sale. For full details of any applicable warranty, you are referred to our original equipment supplier (OEM)

12 DISPOSAL

12.1 WEEE (WASTE ELECTRICAL AND ELECTRONIC EQUIPMENT)

If you use electrical and electronic equipment you must store, collect, treat, recycle and dispose of WEEE separately from your other waste



This Page is Intentionally Blank

This Page is Intentionally Blank